

BENTLEY
RESIDENCES

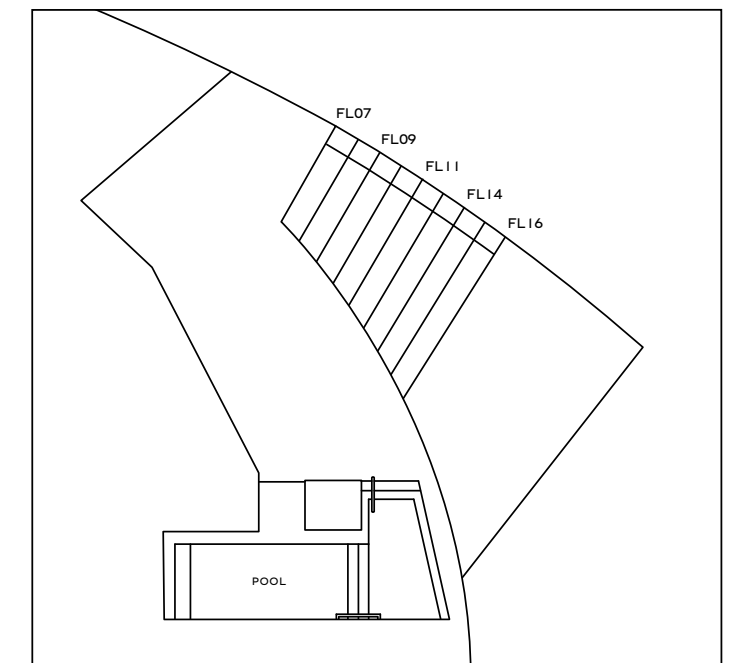

RESIDENCE ARRANGE
3 BEDS | 3.5 BATHS
 FLOORS 07 , 61

INTERIOR	3,014 SQ. FT.	280.00 SQ. M.
BALCONY	1,132 SQ. FT.	105.17 SQ. M.
GARAGE	1,552 SQ. FT.	144.19 SQ. M.
TOTAL	5,698 SQ. FT.	529.36 SQ. M.

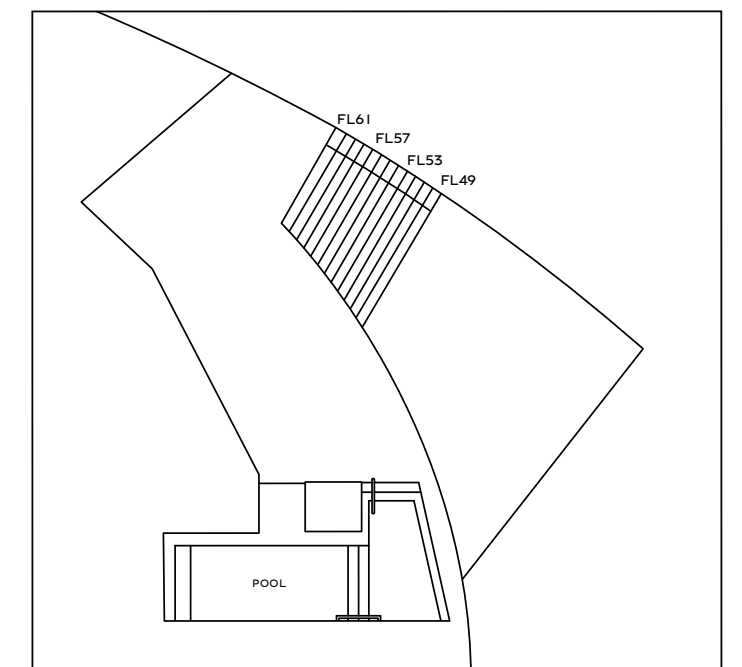

TERRACE AREA VARIES BY FLOOR

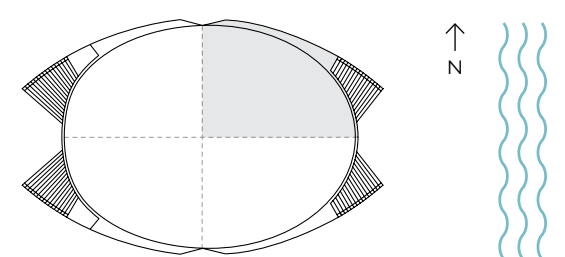

ORAL REPRESENTATIONS CANNOT BE RELIED UPON AS CORRECTLY STATING THE REPRESENTATIONS OF THE DEVELOPER. FOR CORRECT REPRESENTATIONS, MAKE REFERENCE TO THIS BROCHURE AND TO THE DOCUMENTS REQUIRED BY SECTION 718.503, FLORIDA STATUTES, TO BE FURNISHED BY A DEVELOPER TO A BUYER OR LESSEE. Stated dimensions are measured to the exterior boundaries of the exterior walls and the centerline of interior demising walls and in fact vary from the dimensions that would be determined by using the description and definition of the "Unit" set forth in the Declaration (which generally only includes the interior airspace between the perimeter walls and excludes interior structural components). For your reference, the area of the Unit, determined in accordance with those defined unit boundaries, is described on Exhibit 3 to the Declaration. Note that measurements of rooms set forth on this floor plan are generally taken at the greatest points of each given room (as if the room were a perfect rectangle), without regard for any cutouts. Accordingly, the area of the actual room will typically be smaller than the product obtained by multiplying the stated length times width. All dimensions are approximate and may vary with actual construction, and all floor plans and development plans are subject to change. The name 'Bentley' is a registered trademark. © 2022 Bentley Residences.



Sales Gallery: 18325 Collins Avenue, Sunny Isles Beach, FL 33160
Tel 305 BENTLEY (305 236 8539) bentleyresidencesmiami.com

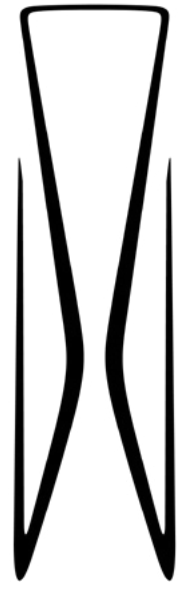

BENTLEY
RESIDENCES

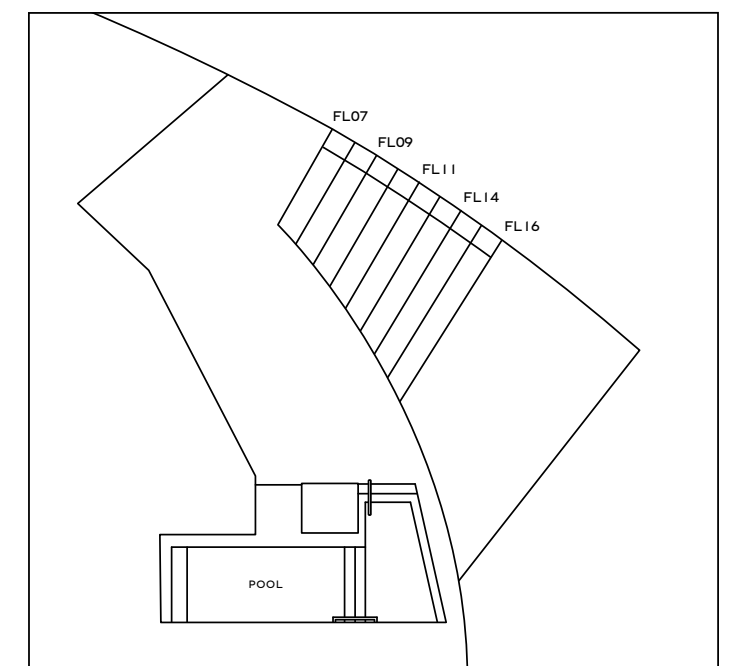
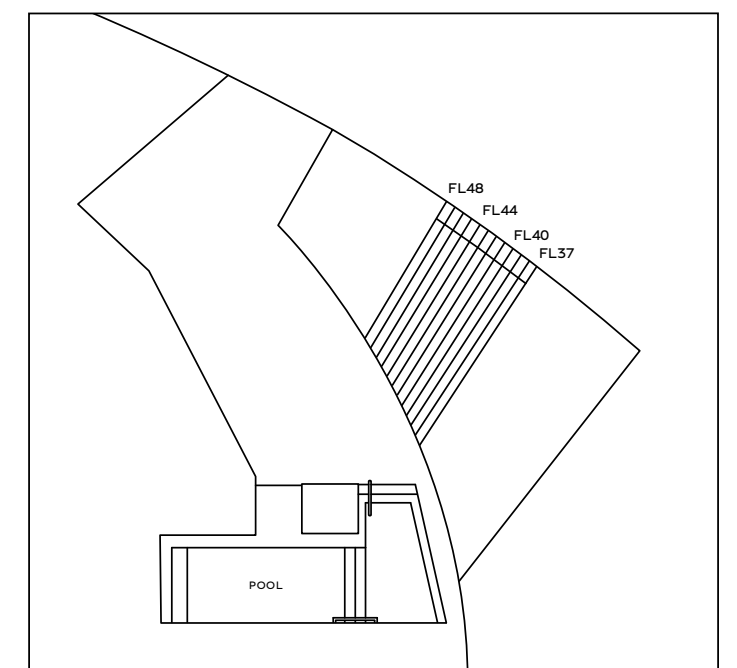
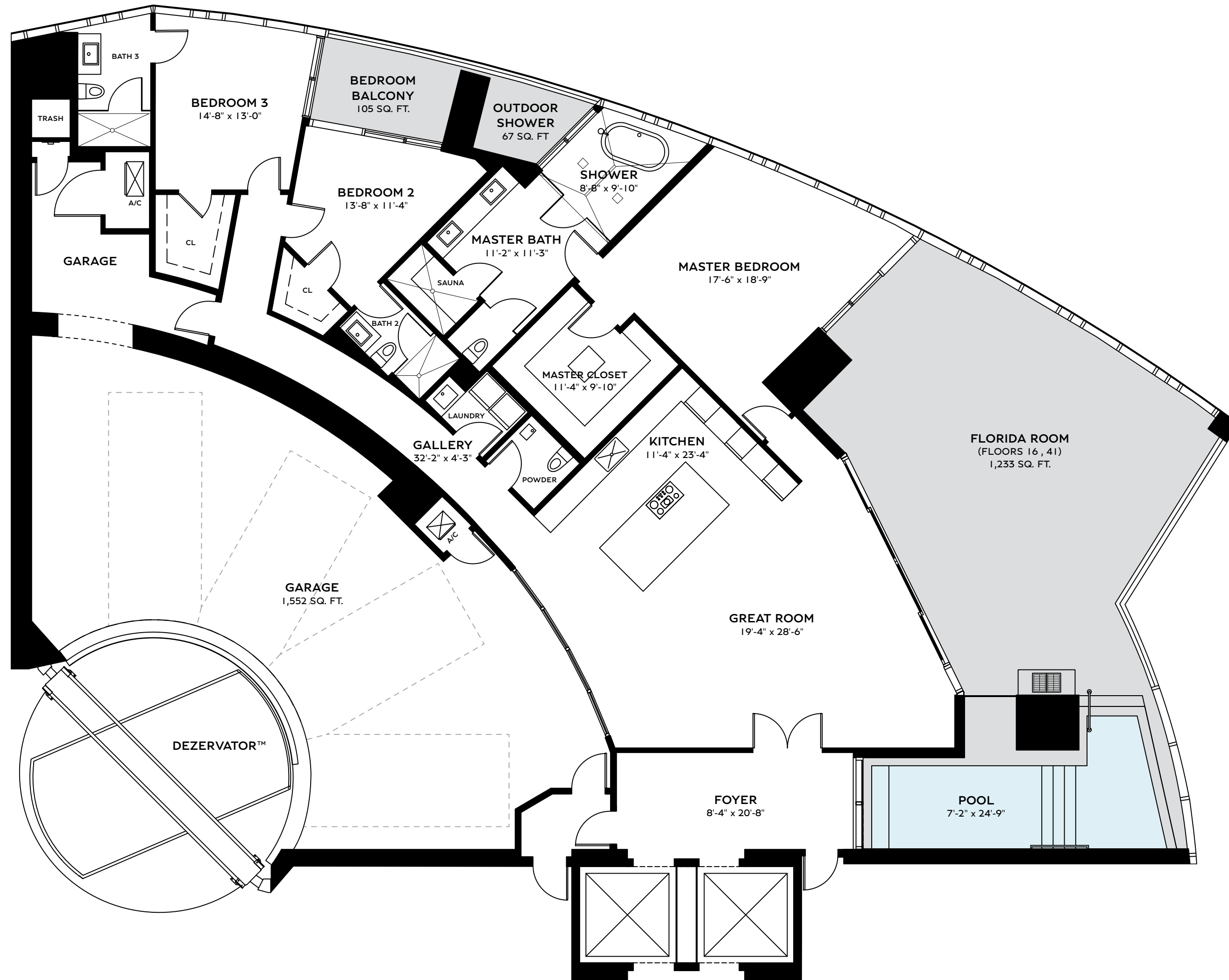

TERRACE AREA VARIES BY FLOOR

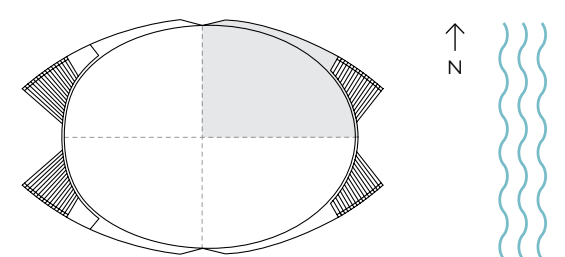

ORAL REPRESENTATIONS CANNOT BE RELIED UPON AS CORRECTLY STATING THE REPRESENTATIONS OF THE DEVELOPER. FOR CORRECT REPRESENTATIONS, MAKE REFERENCE TO THIS BROCHURE AND TO THE DOCUMENTS REQUIRED BY SECTION 718.503, FLORIDA STATUTES, TO BE FURNISHED BY A DEVELOPER TO A BUYER OR LESSEE. Stated dimensions are measured to the exterior boundaries of the exterior walls and the centerline of interior demising walls and in fact vary from the dimensions that would be determined by using the description and definition of the "Unit" set forth in the Declaration (which generally only includes the interior airspace between the perimeter walls and excludes interior structural components). For your reference, the area of the Unit, determined in accordance with those defined unit boundaries, is described on Exhibit 3 to the Declaration. Note that measurements of rooms set forth on this floor plan are generally taken at the greatest points of each given room (as if the room were a perfect rectangle), without regard for any cutouts. Accordingly, the area of the actual room will typically be smaller than the product obtained by multiplying the stated length times width. All dimensions are approximate and may vary with actual construction, and all floor plans and development plans are subject to change. The name 'Bentley' is a registered trademark. © 2022 Bentley Residences.



Sales Gallery: 18325 Collins Avenue, Sunny Isles Beach, FL 33160
Tel 305 BENTLEY (305 236 8539) bentleyresidencesmiami.com

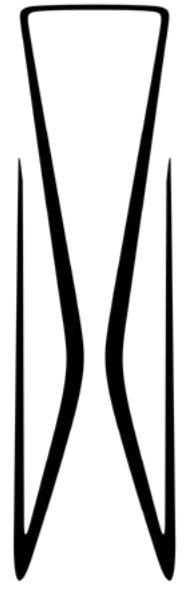

BENTLEY
RESIDENCES

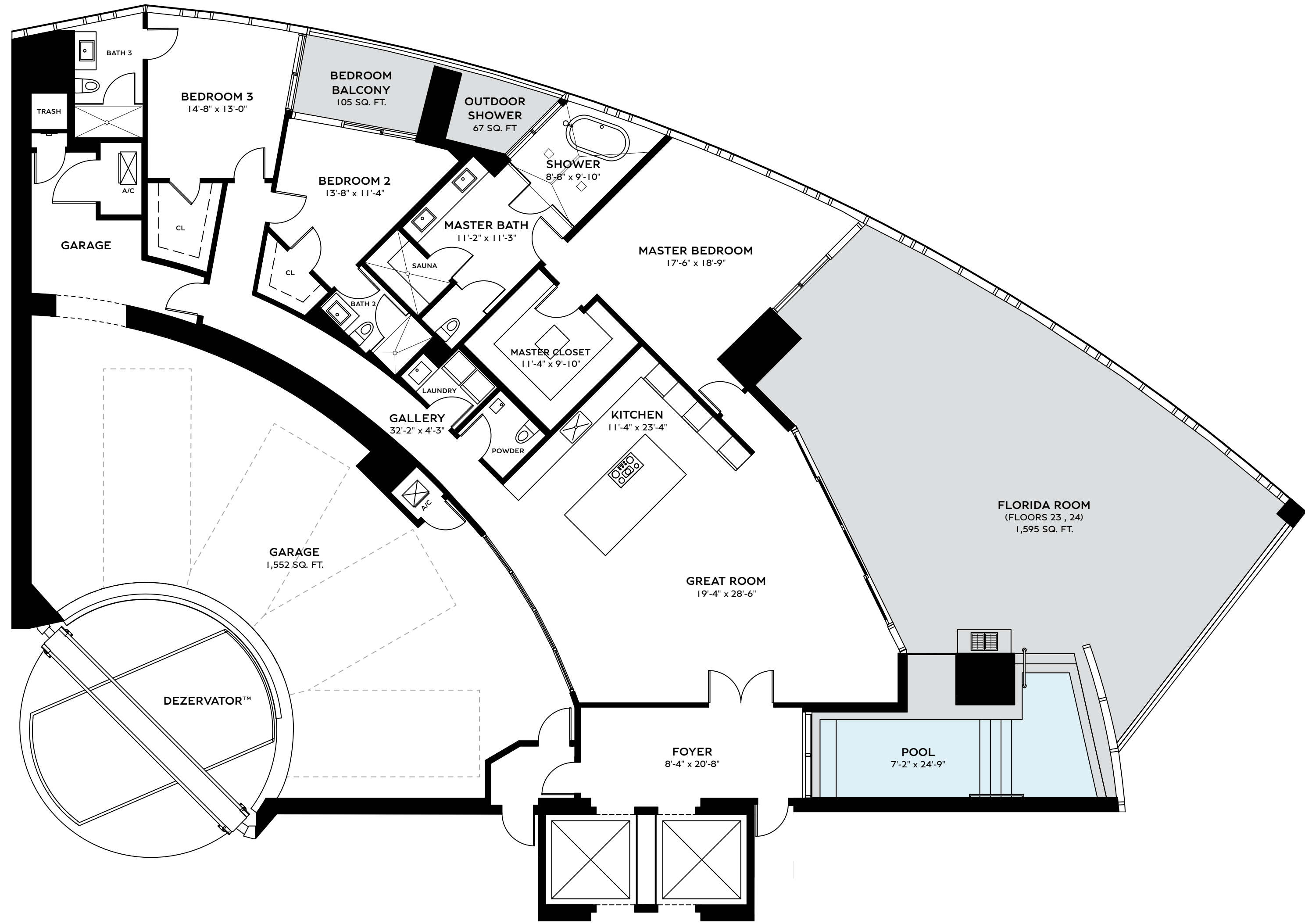

RESIDENCE ARNAGE
3 BEDS | 3.5 BATHS
FLOORS 23 , 24

INTERIOR	3,014 SQ. FT.	280.00 SQ. M.
BALCONY	1,767 SQ. FT.	164.16 SQ. M.
GARAGE	1,552 SQ. FT.	144.19 SQ. M.
TOTAL	6,333 SQ. FT.	588.35 SQ. M.

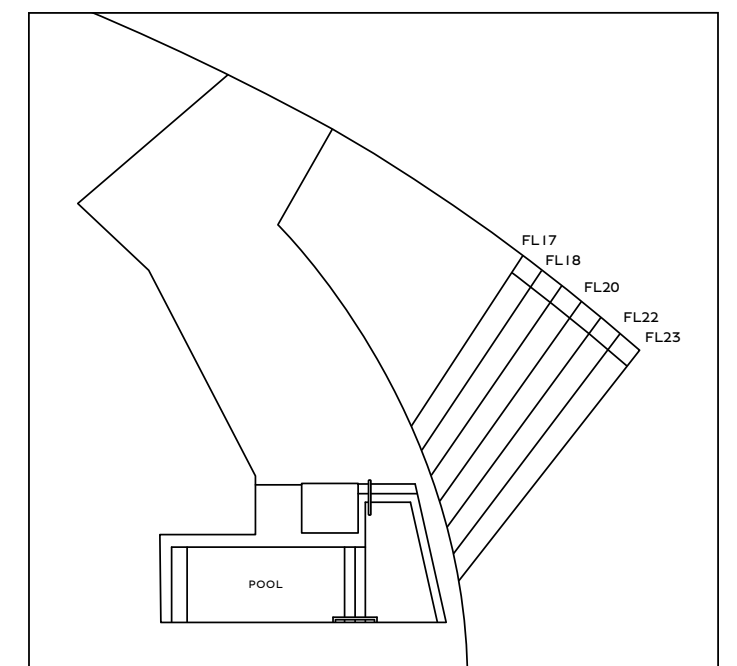
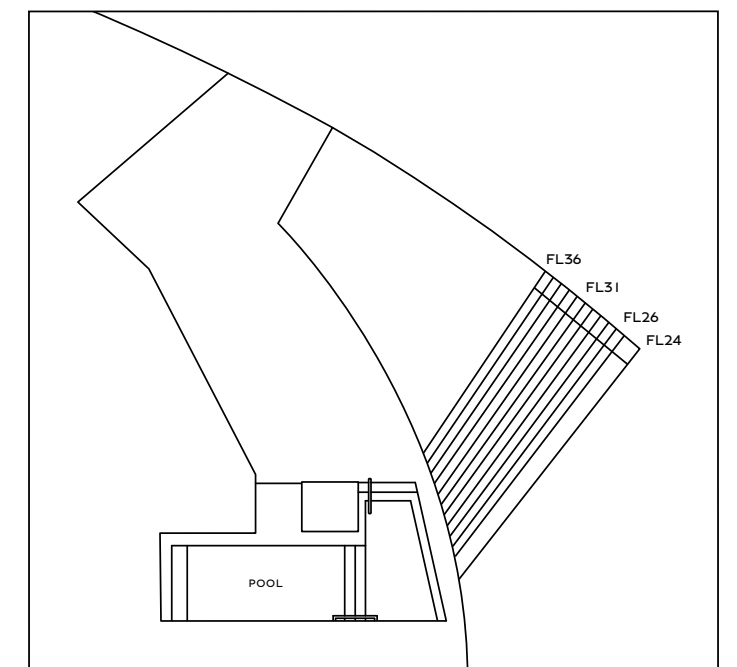

TERRACE AREA VARIES BY FLOOR

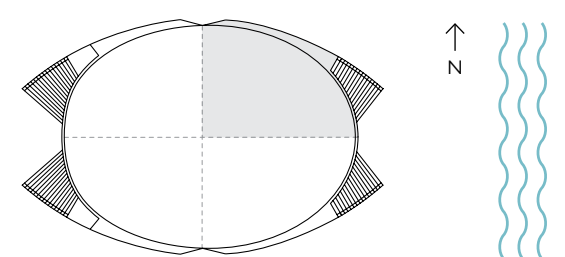

ORAL REPRESENTATIONS CANNOT BE RELIED UPON AS CORRECTLY STATING THE REPRESENTATIONS OF THE DEVELOPER. FOR CORRECT REPRESENTATIONS, MAKE REFERENCE TO THIS BROCHURE AND TO THE DOCUMENTS REQUIRED BY SECTION 718.503, FLORIDA STATUTES, TO BE FURNISHED BY A DEVELOPER TO A BUYER OR LESSEE. Stated dimensions are measured to the exterior boundaries of the exterior walls and the centerline of interior demising walls and in fact vary from the dimensions that would be determined by using the description and definition of the "Unit" set forth in the Declaration (which generally only includes the interior airspace between the perimeter walls and excludes interior structural components). For your reference, the area of the Unit, determined in accordance with those defined unit boundaries, is described on Exhibit 3 to the Declaration. Note that measurements of rooms set forth on this floor plan are generally taken at the greatest points of each given room (as if the room were a perfect rectangle), without regard for any cutouts. Accordingly, the area of the actual room will typically be smaller than the product obtained by multiplying the stated length times width. All dimensions are approximate and may vary with actual construction, and all floor plans and development plans are subject to change. The name 'Bentley' is a registered trademark. © 2022 Bentley Residences.



Sales Gallery: 18325 Collins Avenue, Sunny Isles Beach, FL 33160
Tel 305 BENTLEY (305 236 8539) bentleyresidencesmiami.com



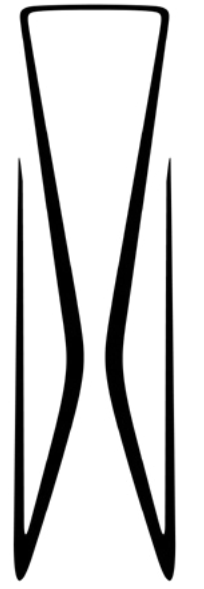

BENTLEY
RESIDENCES

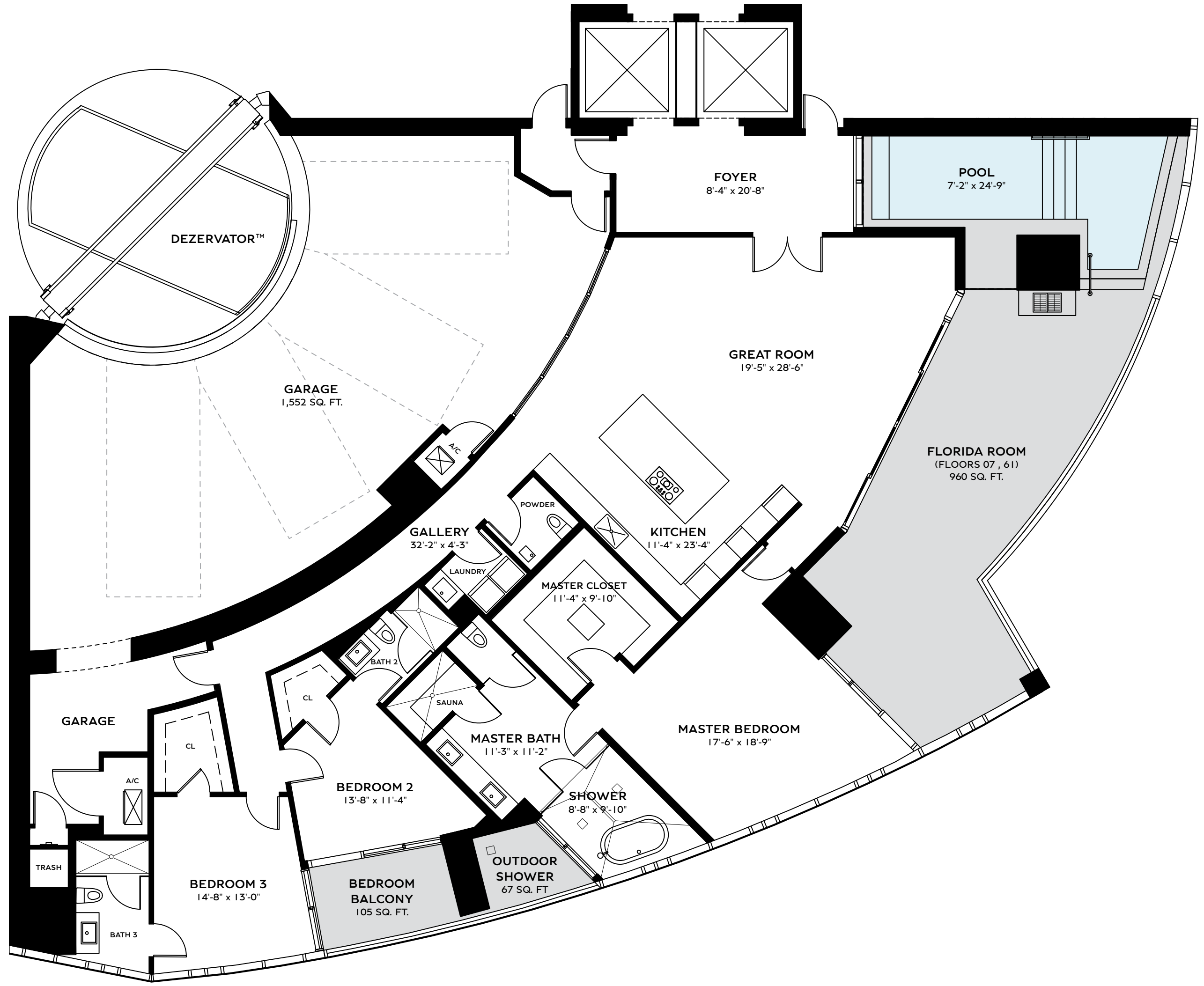

RESIDENCE AZURE
3 BEDS | 3.5 BATHS

FLOORS 07 , 61

INTERIOR	3,014 SQ. FT.	280.00 SQ. M.
BALCONY	1,132 SQ. FT.	105.17 SQ. M.
GARAGE	1,552 SQ. FT.	144.19 SQ. M.
TOTAL	5,698 SQ. FT.	529.36 SQ. M.

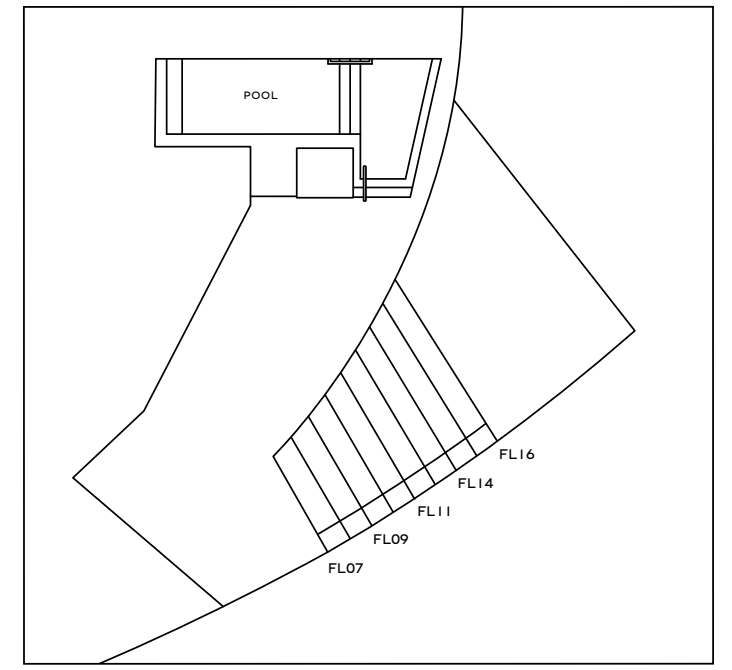
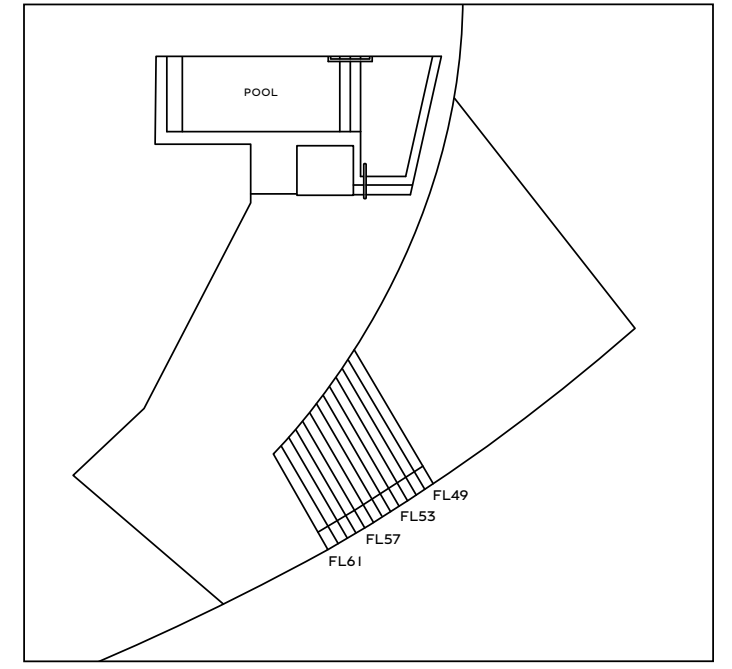

TERRACE AREA VARIES BY FLOOR

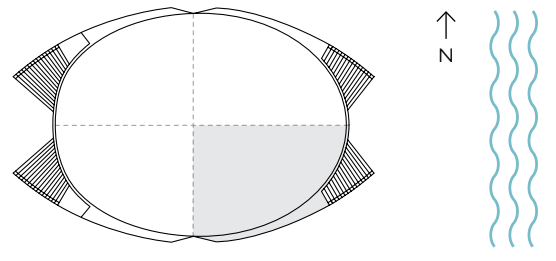

ORAL REPRESENTATIONS CANNOT BE RELIED UPON AS CORRECTLY STATING THE REPRESENTATIONS OF THE DEVELOPER. FOR CORRECT REPRESENTATIONS, MAKE REFERENCE TO THIS BROCHURE AND TO THE DOCUMENTS REQUIRED BY SECTION 718.503, FLORIDA STATUTES, TO BE FURNISHED BY A DEVELOPER TO A BUYER OR LESSEE. Stated dimensions are measured to the exterior boundaries of the exterior walls and the centerline of interior demising walls and in fact vary from the dimensions that would be determined by using the description and definition of the "Unit" set forth in the Declaration (which generally only includes the interior airspace between the perimeter walls and excludes interior structural components). For your reference, the area of the Unit, determined in accordance with those defined unit boundaries, is described on Exhibit 3 to the Declaration. Note that measurements of rooms set forth on this floor plan are generally taken at the greatest points of each given room (as if the room were a perfect rectangle), without regard for any cutouts. Accordingly, the area of the actual room will typically be smaller than the product obtained by multiplying the stated length times width. All dimensions are approximate and may vary with actual construction, and all floor plans and development plans are subject to change. The name 'Bentley' is a registered trademark. © 2022 Bentley Residences.



Sales Gallery: 18325 Collins Avenue, Sunny Isles Beach, FL 33160
Tel 305 BENTLEY (305 236 8539) bentleyresidencesmiami.com

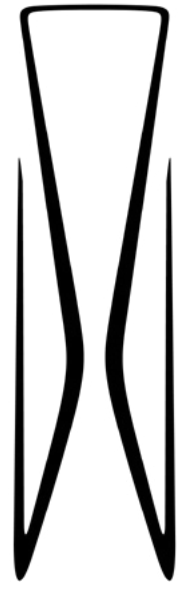

B
BENTLEY
RESIDENCES

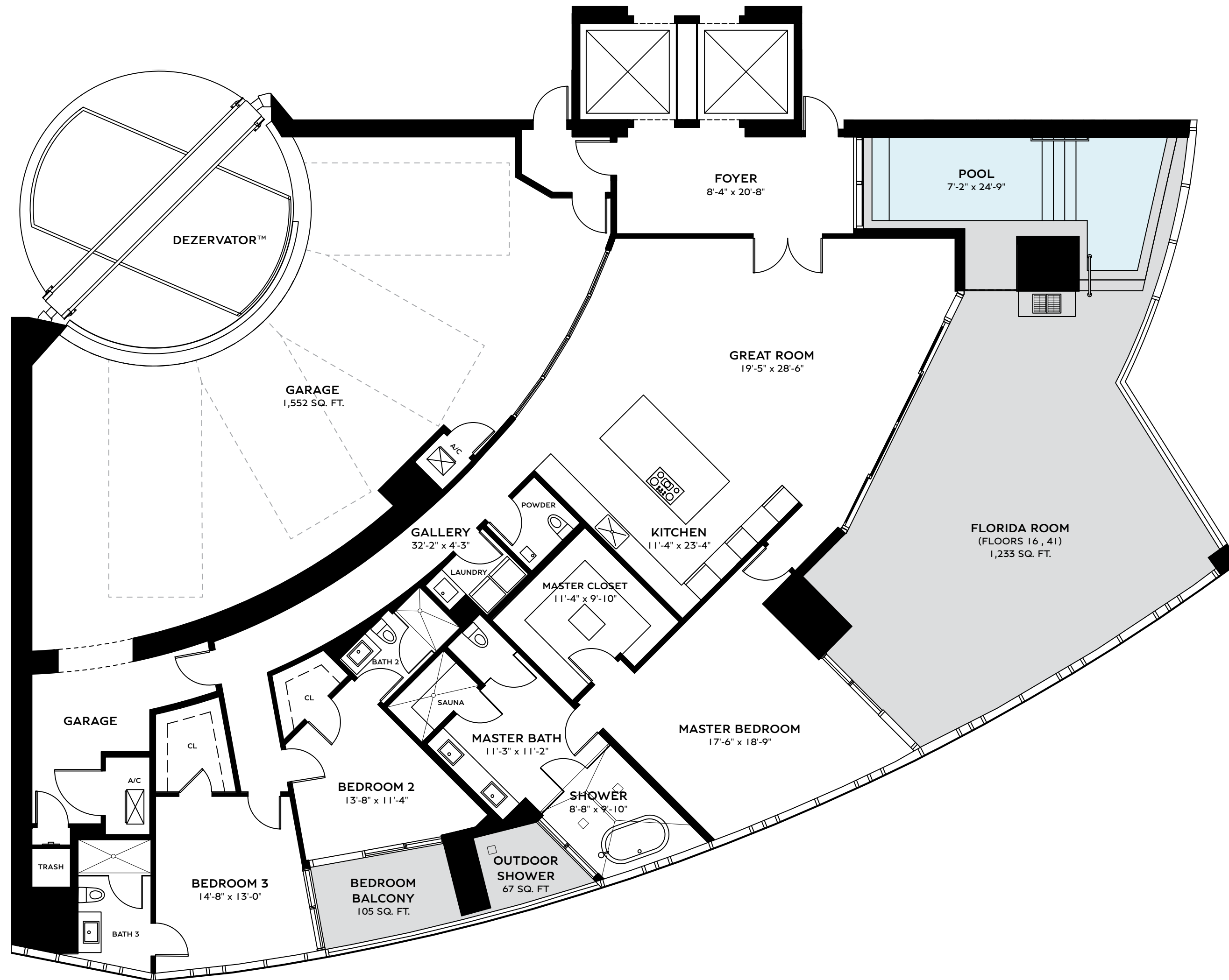

RESIDENCE AZURE
3 BEDS | 3.5 BATHS

FLOORS 16, 41

INTERIOR	3,014 SQ. FT.	280.00 SQ. M.
BALCONY	1,405 SQ. FT.	130.53 SQ. M.
GARAGE	1,552 SQ. FT.	144.19 SQ. M.
TOTAL	5,971 SQ. FT.	554.72 SQ. M.

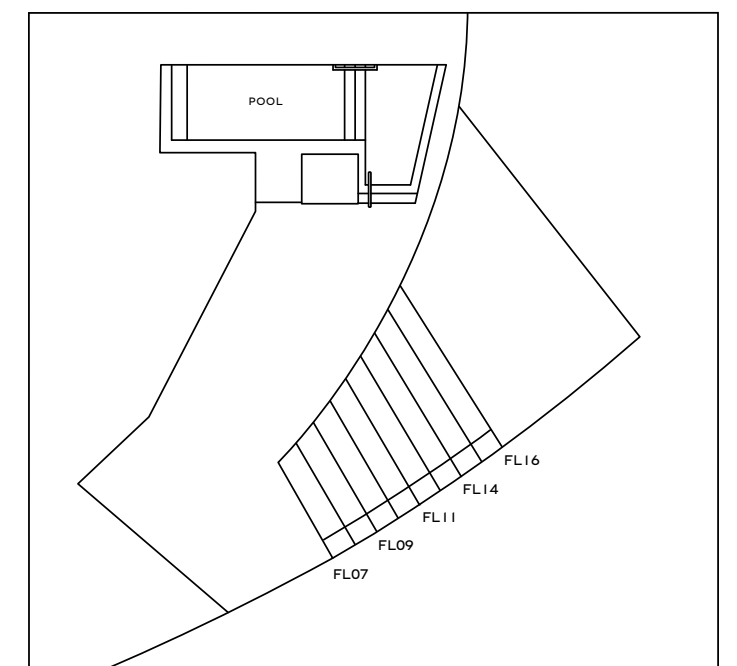
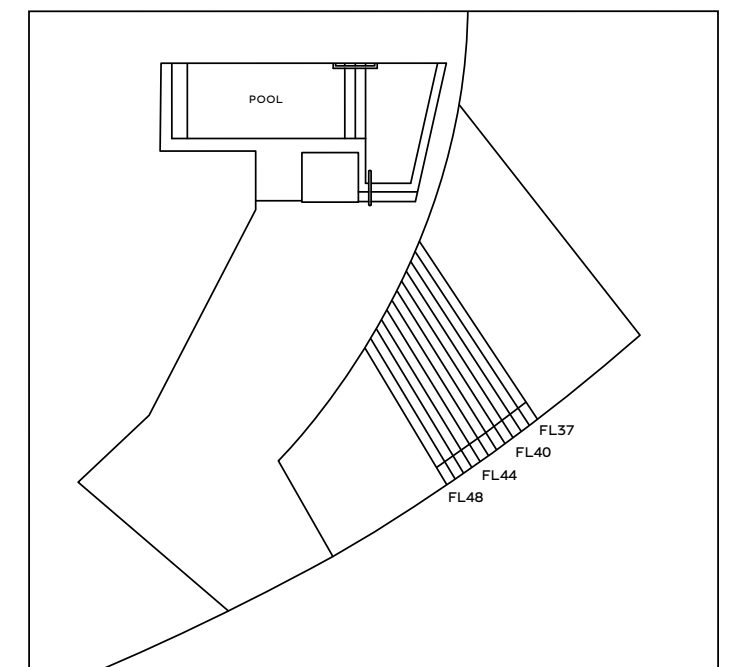

TERRACE AREA VARIES BY FLOOR

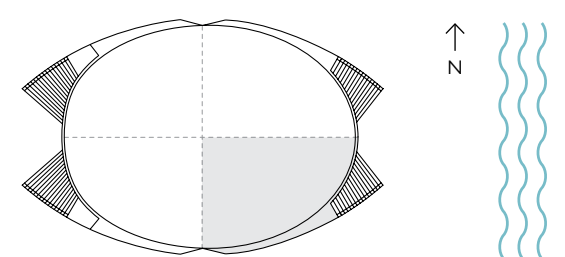

ORAL REPRESENTATIONS CANNOT BE RELIED UPON AS CORRECTLY STATING THE REPRESENTATIONS OF THE DEVELOPER. FOR CORRECT REPRESENTATIONS, MAKE REFERENCE TO THIS BROCHURE AND TO THE DOCUMENTS REQUIRED BY SECTION 718.503, FLORIDA STATUTES, TO BE FURNISHED BY A DEVELOPER TO A BUYER OR LESSEE. Stated dimensions are measured to the exterior boundaries of the exterior walls and the centerline of interior demising walls and in fact vary from the dimensions that would be determined by using the description and definition of the "Unit" set forth in the Declaration (which generally only includes the interior airspace between the perimeter walls and excludes interior structural components). For your reference, the area of the Unit, determined in accordance with those defined unit boundaries, is described on Exhibit 3 to the Declaration. Note that measurements of rooms set forth on this floor plan are generally taken at the greatest points of each given room (as if the room were a perfect rectangle), without regard for any cutouts. Accordingly, the area of the actual room will typically be smaller than the product obtained by multiplying the stated length times width. All dimensions are approximate and may vary with actual construction, and all floor plans and development plans are subject to change. The name 'Bentley' is a registered trademark. © 2022 Bentley Residences.



Sales Gallery: 18325 Collins Avenue, Sunny Isles Beach, FL 33160
Tel 305 BENTLEY (305 236 8539) bentleyresidencesmiami.com

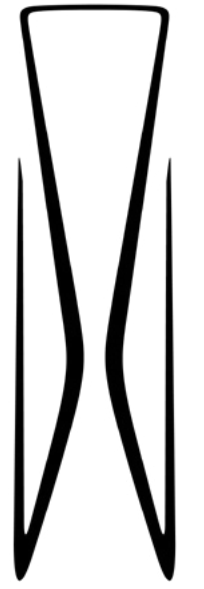

BENTLEY
RESIDENCES

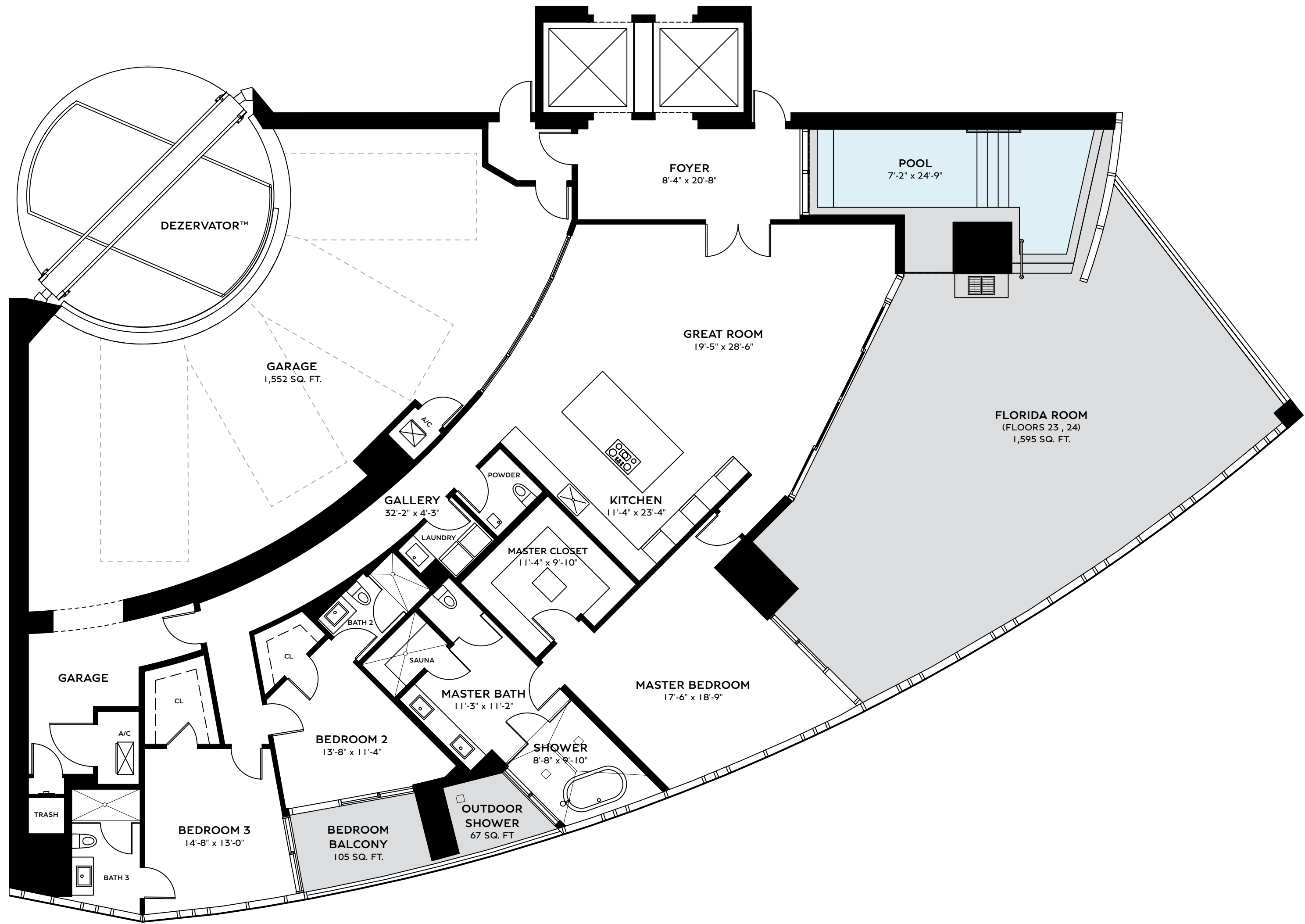

RESIDENCE AZURE
3 BEDS | 3.5 BATHS
FLOORS 23 , 24

INTERIOR	3,014 SQ. FT.	280.00 SQ. M.
BALCONY	1,767 SQ. FT.	164.16 SQ. M.
GARAGE	1,552 SQ. FT.	144.19 SQ. M.
TOTAL	6,333 SQ. FT.	588.35 SQ. M.

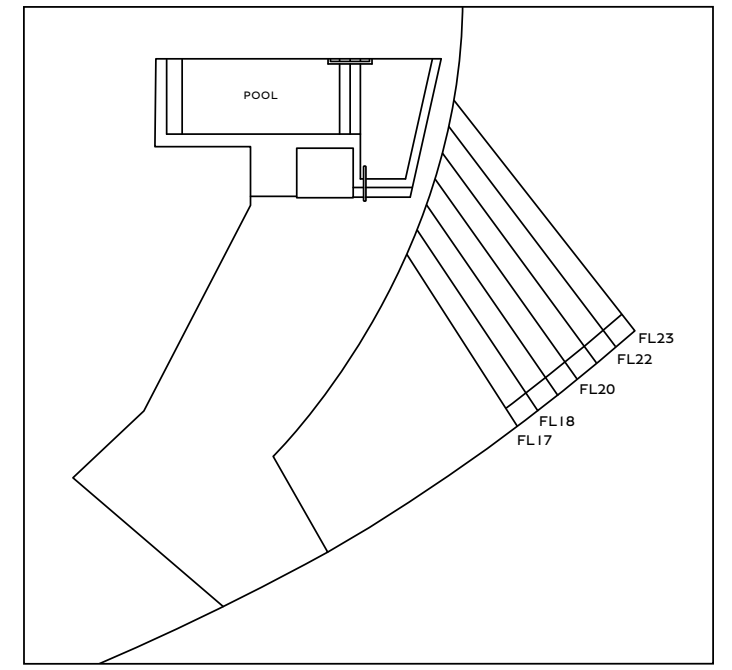
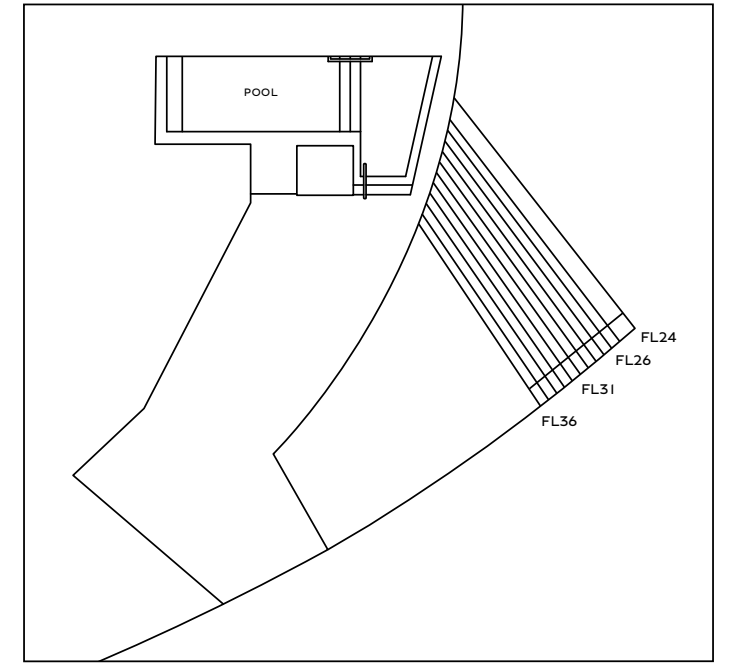

TERRACE AREA VARIES BY FLOOR

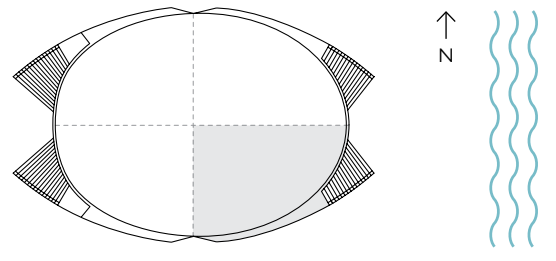

ORAL REPRESENTATIONS CANNOT BE RELIED UPON AS CORRECTLY STATING THE REPRESENTATIONS OF THE DEVELOPER. FOR CORRECT REPRESENTATIONS, MAKE REFERENCE TO THIS BROCHURE AND TO THE DOCUMENTS REQUIRED BY SECTION 718.503, FLORIDA STATUTES, TO BE FURNISHED BY A DEVELOPER TO A BUYER OR LESSEE. Stated dimensions are measured to the exterior boundaries of the exterior walls and the centerline of interior demising walls and in fact vary from the dimensions that would be determined by using the description and definition of the "Unit" set forth in the Declaration (which generally only includes the interior airspace between the perimeter walls and excludes interior structural components). For your reference, the area of the Unit, determined in accordance with those defined unit boundaries, is described on Exhibit 3 to the Declaration. Note that measurements of rooms set forth on this floor plan are generally taken at the greatest points of each given room (as if the room were a perfect rectangle), without regard for any cutouts. Accordingly, the area of the actual room will typically be smaller than the product obtained by multiplying the stated length times width. All dimensions are approximate and may vary with actual construction, and all floor plans and development plans are subject to change. The name 'Bentley' is a registered trademark. © 2022 Bentley Residences.



Sales Gallery: 18325 Collins Avenue, Sunny Isles Beach, FL 33160
Tel 305 BENTLEY (305 236 8539) bentleyresidencesmiami.com

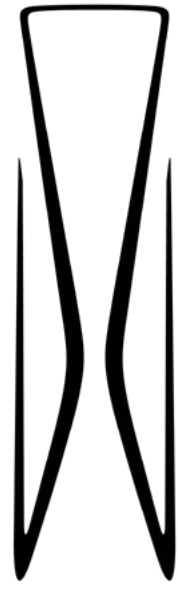

B
BENTLEY
RESIDENCES

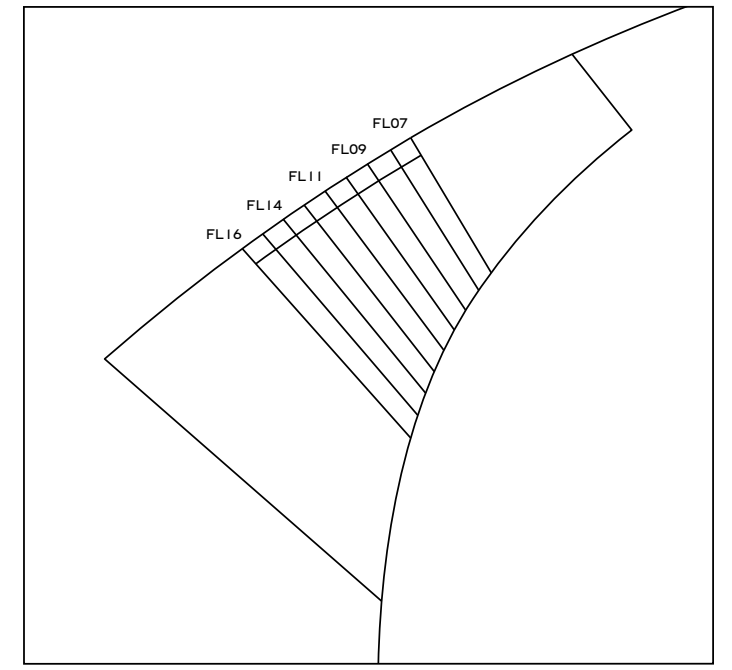
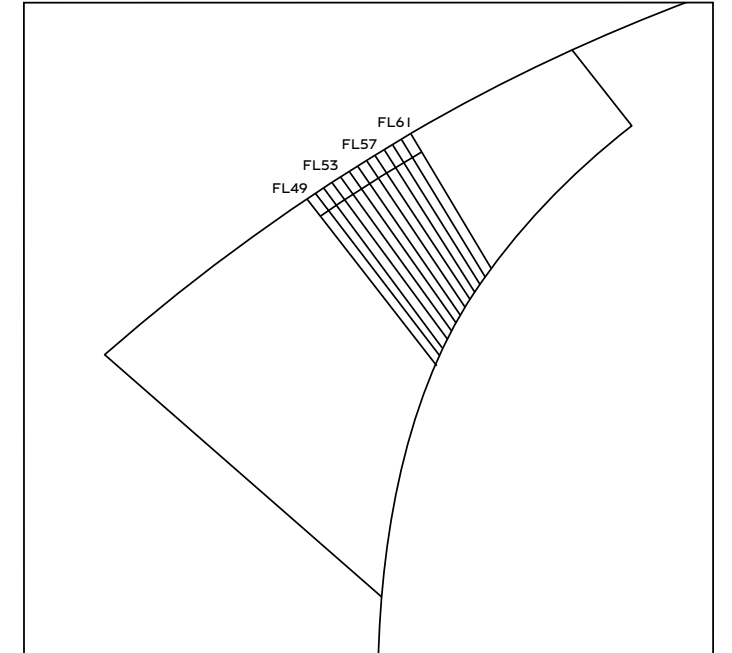
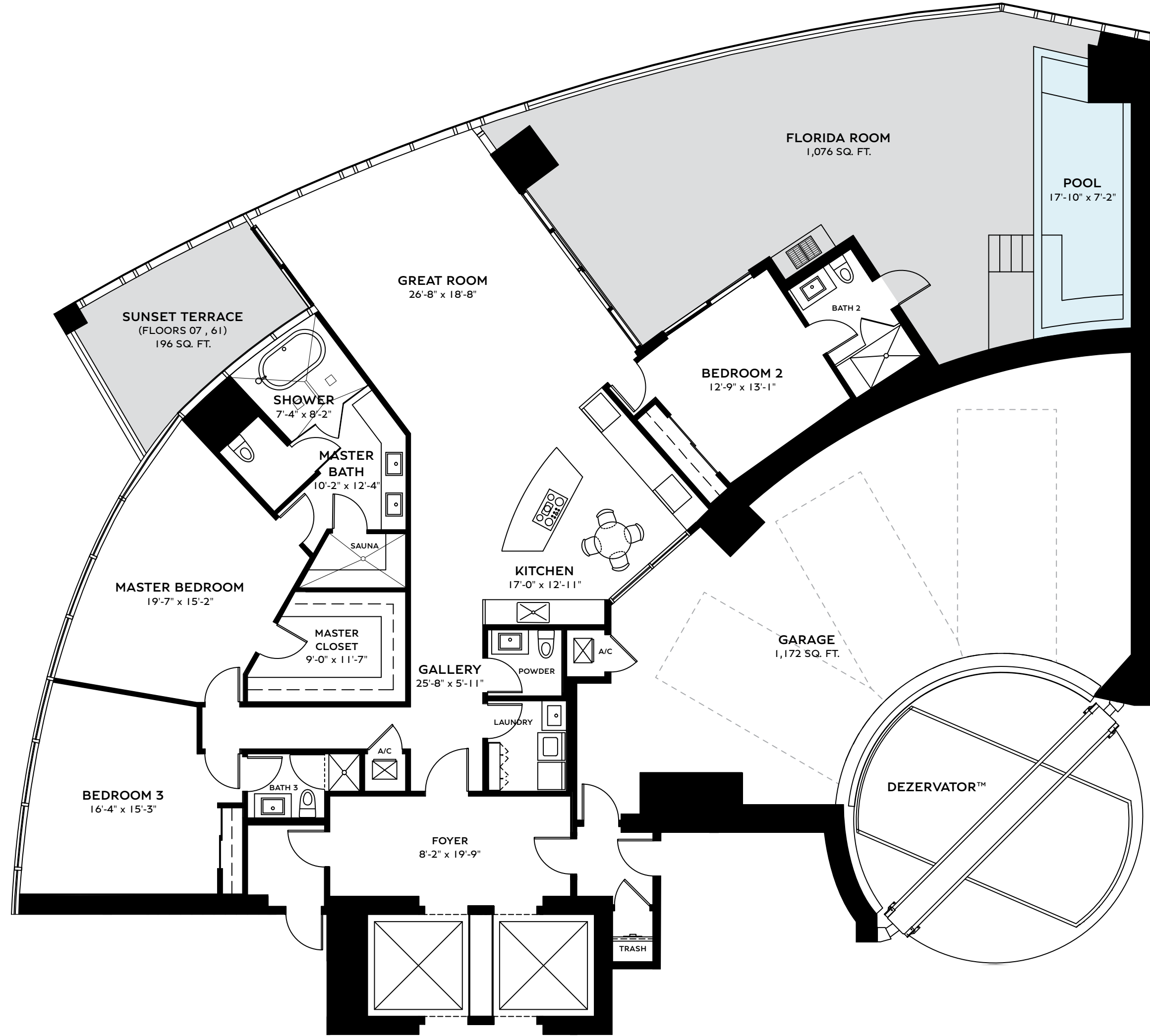

TERRACE AREA VARIES BY FLOOR

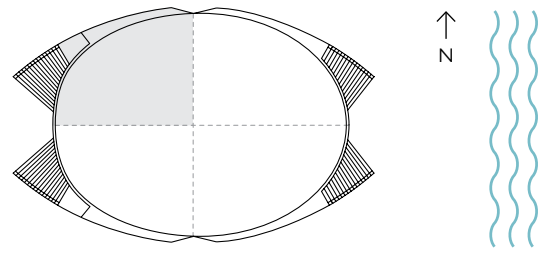

ORAL REPRESENTATIONS CANNOT BE RELIED UPON AS CORRECTLY STATING THE REPRESENTATIONS OF THE DEVELOPER. FOR CORRECT REPRESENTATIONS, MAKE REFERENCE TO THIS BROCHURE AND TO THE DOCUMENTS REQUIRED BY SECTION 718.503, FLORIDA STATUTES, TO BE FURNISHED BY A DEVELOPER TO A BUYER OR LESSEE. Stated dimensions are measured to the exterior boundaries of the exterior walls and the centerline of interior demising walls and in fact vary from the dimensions that would be determined by using the description and definition of the "Unit" set forth in the Declaration (which generally only includes the interior airspace between the perimeter walls and excludes interior structural components). For your reference, the area of the Unit, determined in accordance with those defined unit boundaries, is described on Exhibit 3 to the Declaration. Note that measurements of rooms set forth on this floor plan are generally taken at the greatest points of each given room (as if the room were a perfect rectangle), without regard for any cutouts. Accordingly, the area of the actual room will typically be smaller than the product obtained by multiplying the stated length times width. All dimensions are approximate and may vary with actual construction, and all floor plans and development plans are subject to change. The name 'Bentley' is a registered trademark. © 2022 Bentley Residences.



Sales Gallery: 18325 Collins Avenue, Sunny Isles Beach, FL 33160
Tel 305 BENTLEY (305 236 8539) bentleyresidencesmiami.com

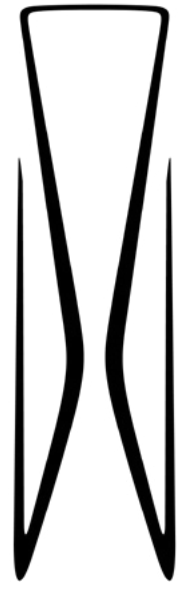

B
BENTLEY
RESIDENCES

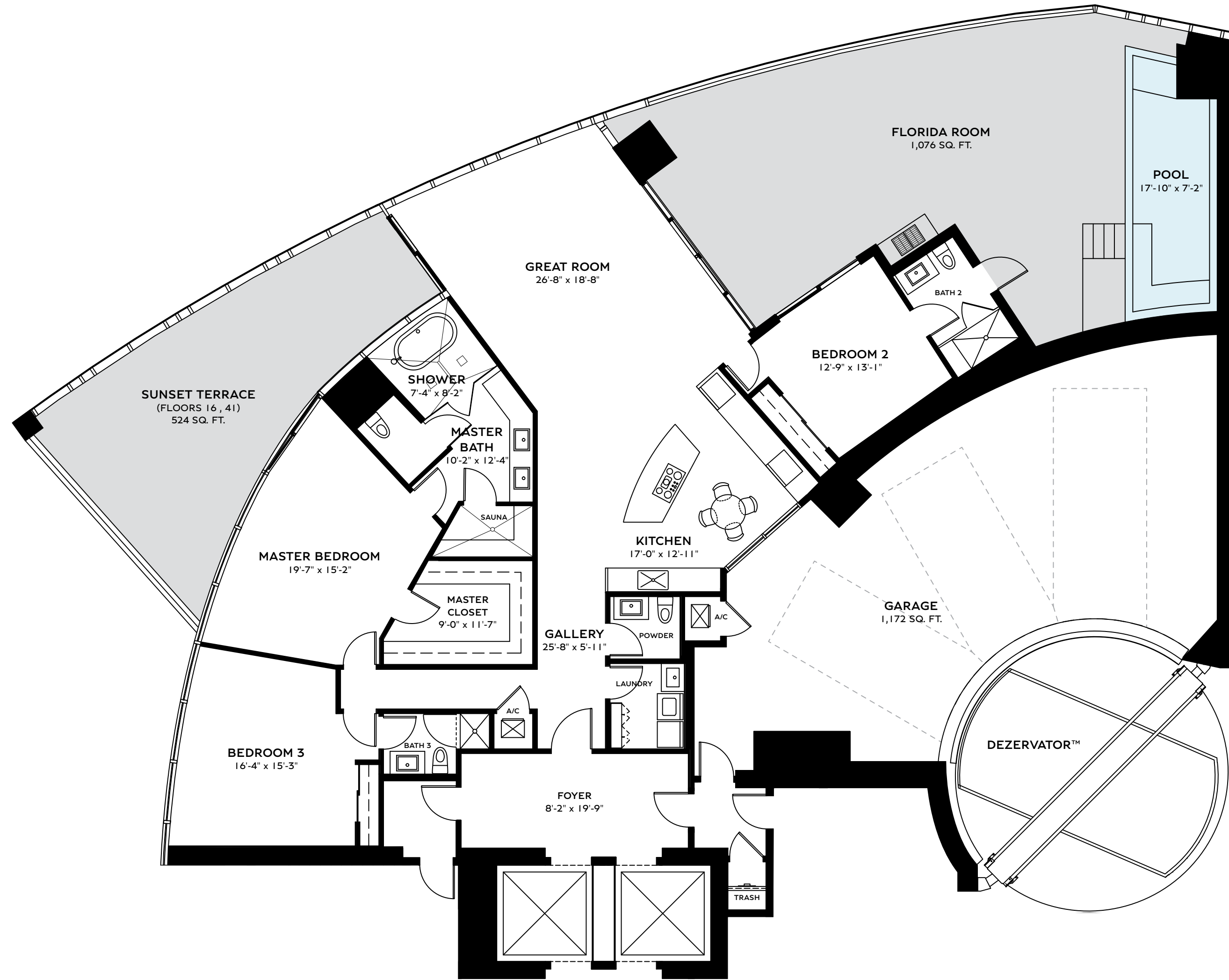

RESIDENCE BACALAR
3 BEDS | 3.5 BATHS

FLOORS 16, 41

INTERIOR	2,839 SQ. FT.	263.75 SQ. M.
BALCONY	1,600 SQ. FT.	148.64 SQ. M.
GARAGE	1,172 SQ. FT.	108.88 SQ. M.
TOTAL	5,611 SQ. FT.	521.27 SQ. M.

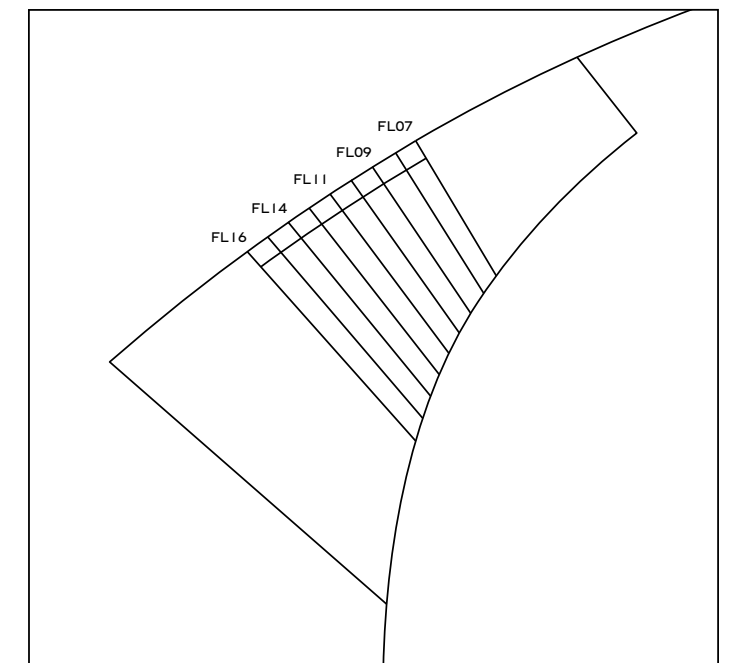
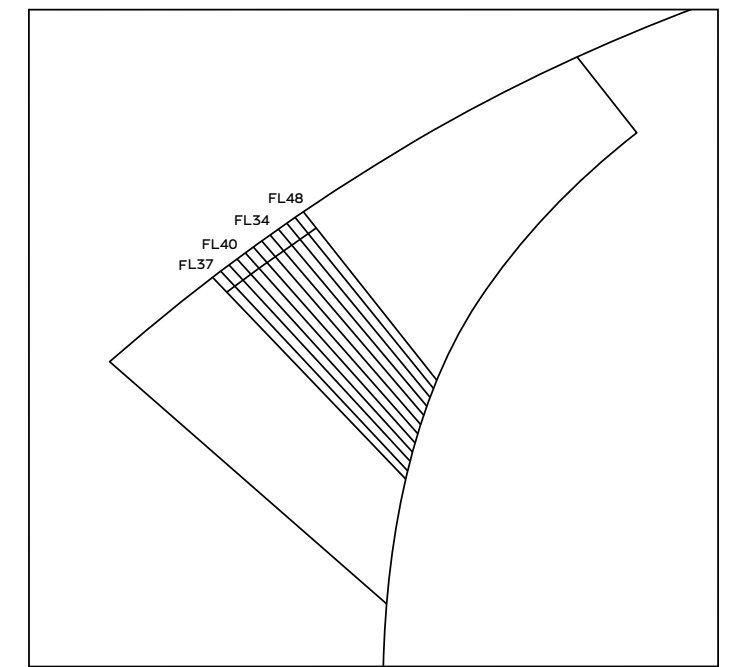

TERRACE AREA VARIES BY FLOOR

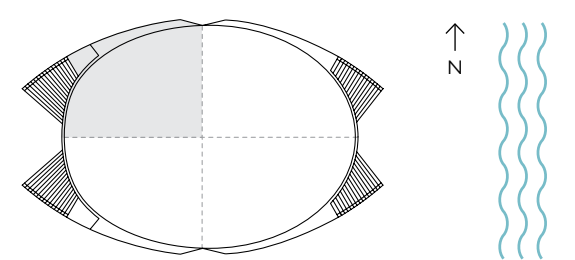

ORAL REPRESENTATIONS CANNOT BE RELIED UPON AS CORRECTLY STATING THE REPRESENTATIONS OF THE DEVELOPER. FOR CORRECT REPRESENTATIONS, MAKE REFERENCE TO THIS BROCHURE AND TO THE DOCUMENTS REQUIRED BY SECTION 718.503, FLORIDA STATUTES, TO BE FURNISHED BY A DEVELOPER TO A BUYER OR LESSEE. Stated dimensions are measured to the exterior boundaries of the exterior walls and the centerline of interior demising walls and in fact vary from the dimensions that would be determined by using the description and definition of the "Unit" set forth in the Declaration (which generally only includes the interior airspace between the perimeter walls and excludes interior structural components). For your reference, the area of the Unit, determined in accordance with those defined unit boundaries, is described on Exhibit 3 to the Declaration. Note that measurements of rooms set forth on this floor plan are generally taken at the greatest points of each given room (as if the room were a perfect rectangle), without regard for any cutouts. Accordingly, the area of the actual room will typically be smaller than the product obtained by multiplying the stated length times width. All dimensions are approximate and may vary with actual construction, and all floor plans and development plans are subject to change. The name 'Bentley' is a registered trademark. © 2022 Bentley Residences.



Sales Gallery: 18325 Collins Avenue, Sunny Isles Beach, FL 33160
Tel 305 BENTLEY (305 236 8539) bentleyresidencesmiami.com

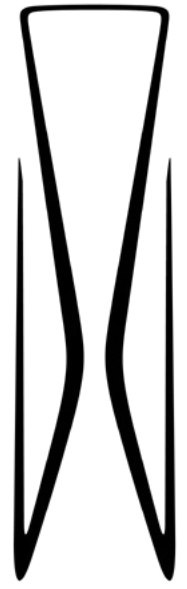

BENTLEY
RESIDENCES

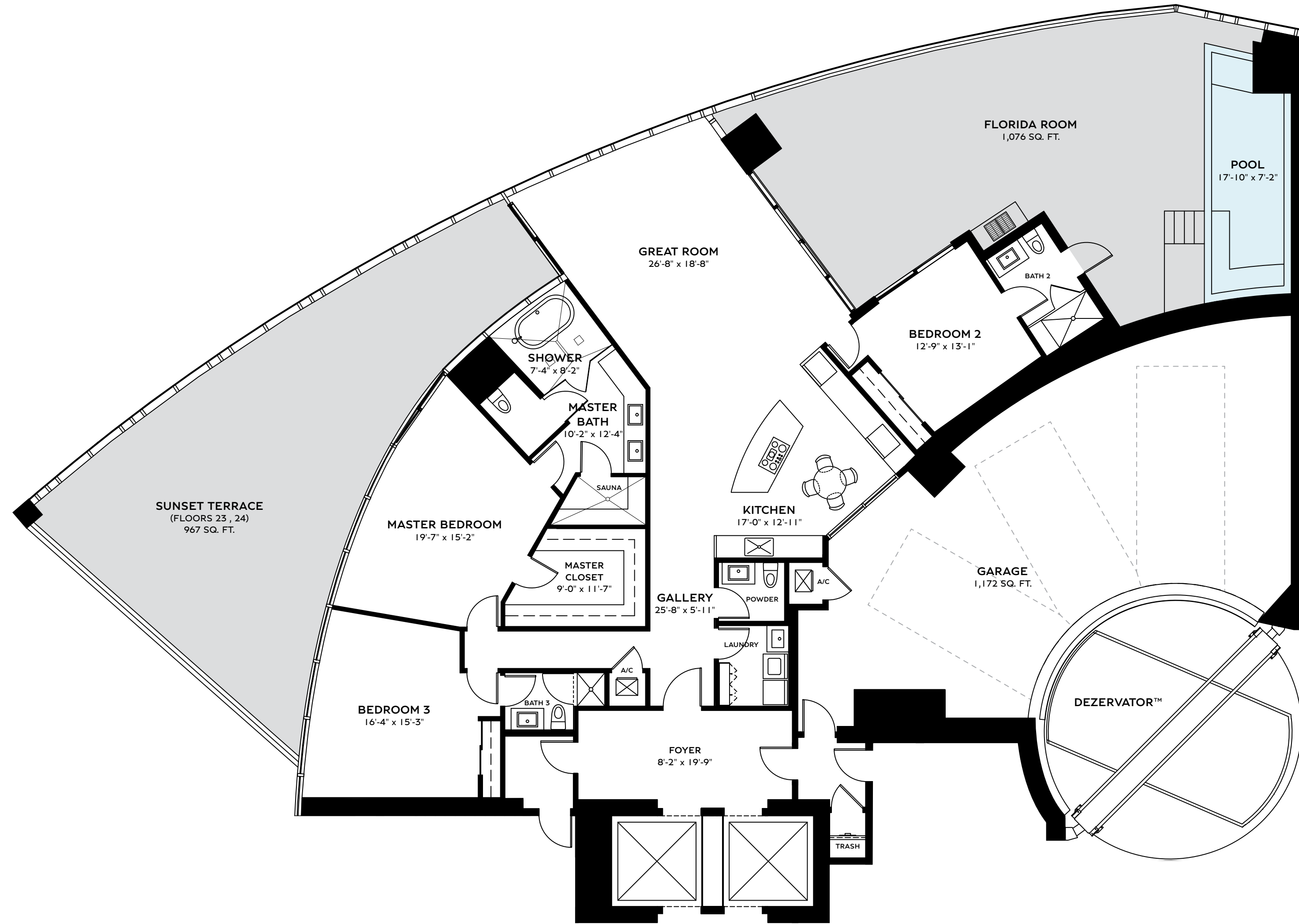

RESIDENCE BACALAR
3 BEDS | 3.5 BATHS

FLOORS 23 , 24

INTERIOR	2,839 SQ. FT.	263.75 SQ. M.
BALCONY	2,043 SQ. FT.	189.80 SQ. M.
GARAGE	1,172 SQ. FT.	108.88 SQ. M.
TOTAL	6,054 SQ. FT.	562.43 SQ. M.

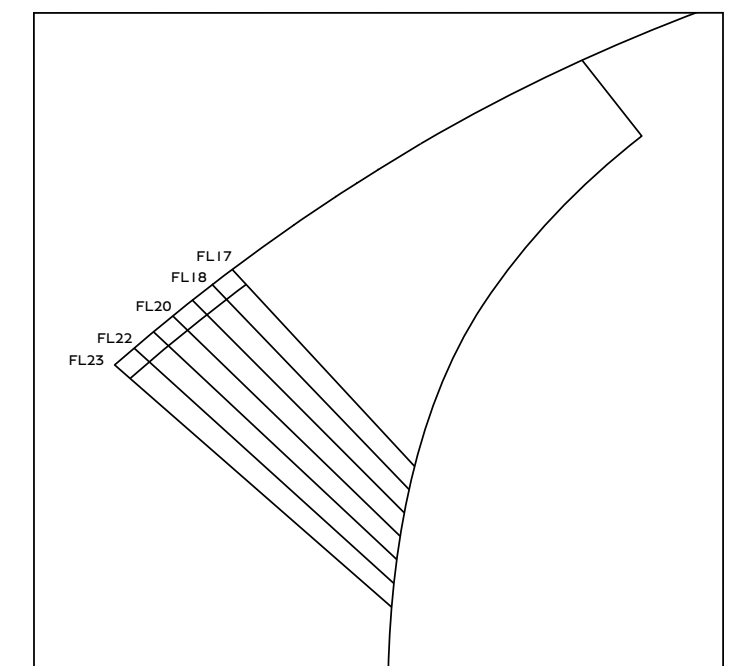
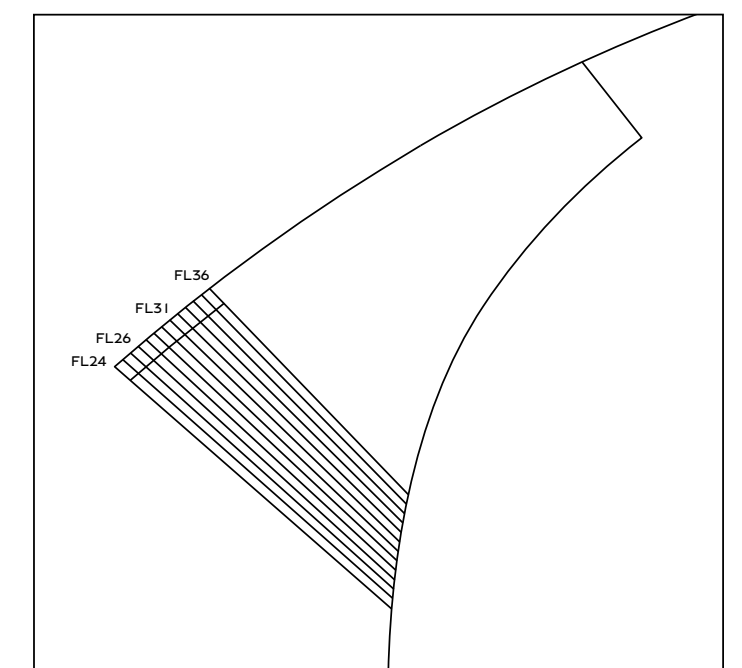

TERRACE AREA VARIES BY FLOOR

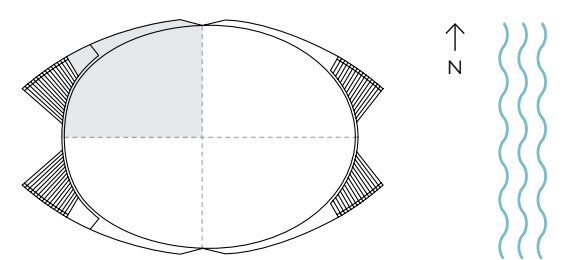

ORAL REPRESENTATIONS CANNOT BE RELIED UPON AS CORRECTLY STATING THE REPRESENTATIONS OF THE DEVELOPER. FOR CORRECT REPRESENTATIONS, MAKE REFERENCE TO THIS BROCHURE AND TO THE DOCUMENTS REQUIRED BY SECTION 718.503, FLORIDA STATUTES, TO BE FURNISHED BY A DEVELOPER TO A BUYER OR LESSEE. Stated dimensions are measured to the exterior boundaries of the exterior walls and the centerline of interior demising walls and in fact vary from the dimensions that would be determined by using the description and definition of the "Unit" set forth in the Declaration (which generally only includes the interior airspace between the perimeter walls and excludes interior structural components). For your reference, the area of the Unit, determined in accordance with those defined unit boundaries, is described on Exhibit 3 to the Declaration. Note that measurements of rooms set forth on this floor plan are generally taken at the greatest points of each given room (as if the room were a perfect rectangle), without regard for any cutouts. Accordingly, the area of the actual room will typically be smaller than the product obtained by multiplying the stated length times width. All dimensions are approximate and may vary with actual construction, and all floor plans and development plans are subject to change. The name 'Bentley' is a registered trademark. © 2022 Bentley Residences.



Sales Gallery: 18325 Collins Avenue, Sunny Isles Beach, FL 33160
Tel 305 BENTLEY (305 236 8539) bentleyresidencesmiami.com

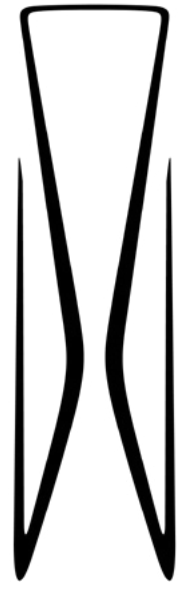

B
BENTLEY
RESIDENCES

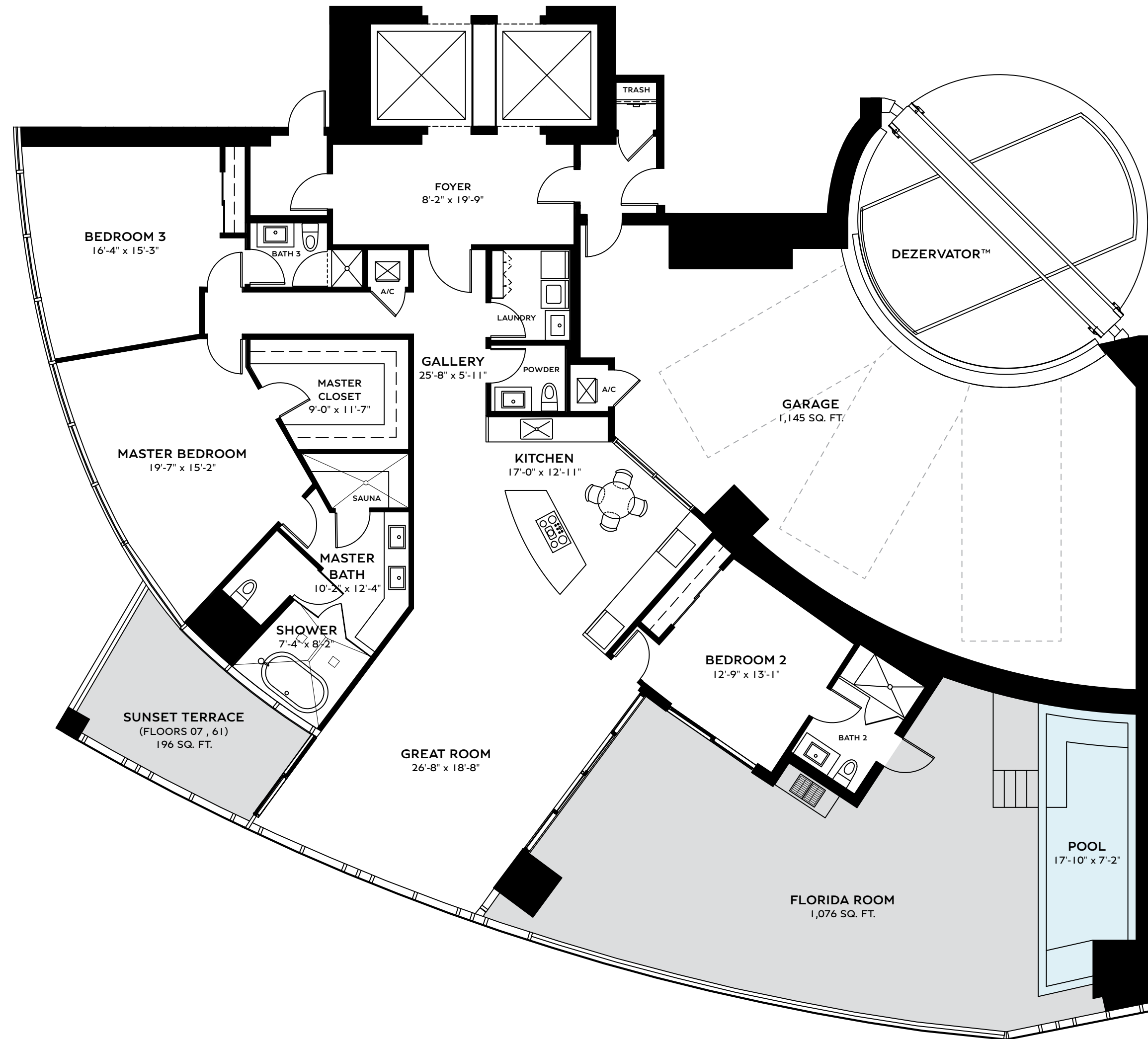

RESIDENCE BENTAYGA
3 BEDS | 3.5 BATHS

FLOORS 07 , 61

INTERIOR	2,839 SQ. FT.	263.75 SQ. M.
BALCONY	1,272 SQ. FT.	118.17 SQ. M.
GARAGE	1,145 SQ. FT.	106.37 SQ. M.
TOTAL	5,256 SQ. FT.	488.29 SQ. M.

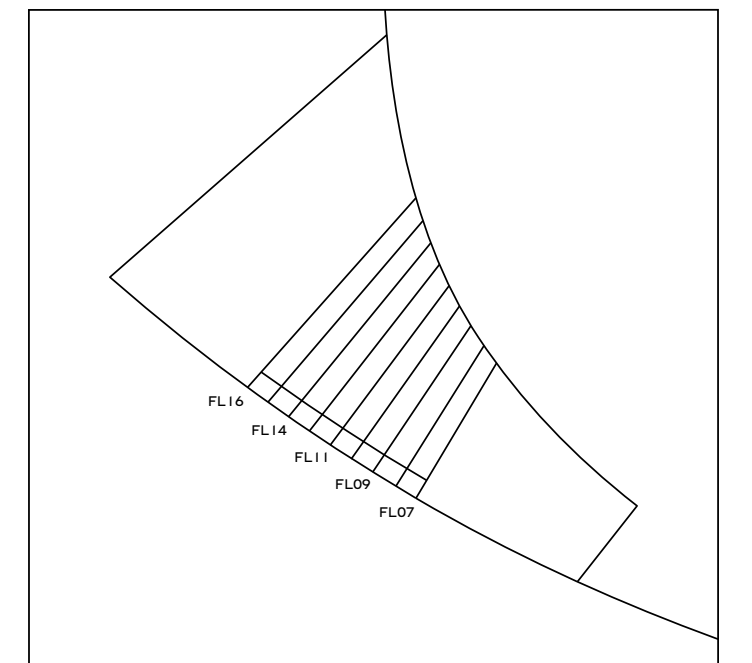
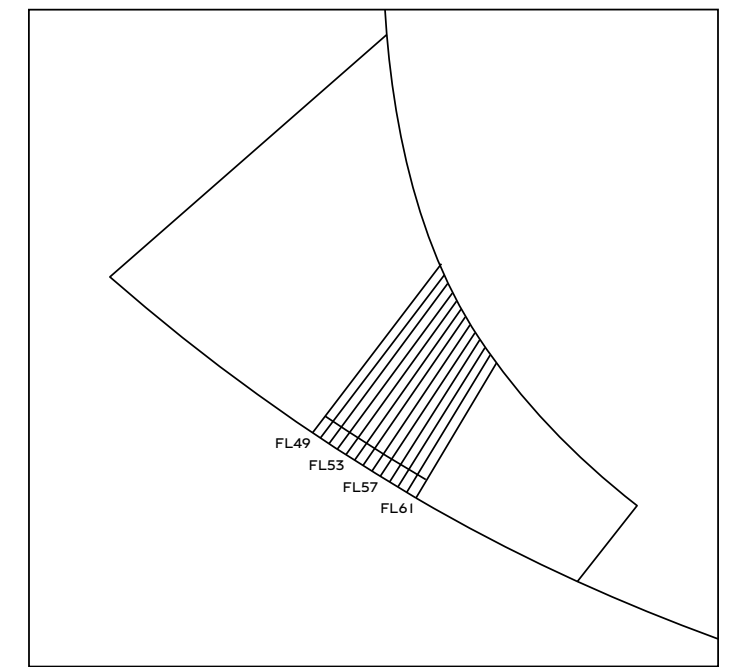

TERRACE AREA VARIES BY FLOOR

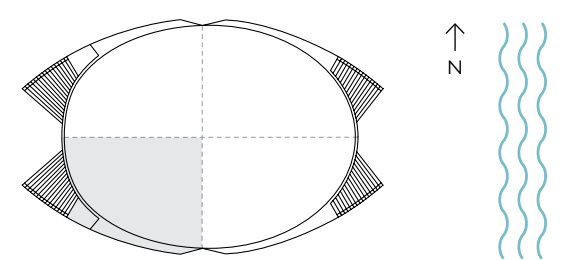

ORAL REPRESENTATIONS CANNOT BE RELIED UPON AS CORRECTLY STATING THE REPRESENTATIONS OF THE DEVELOPER. FOR CORRECT REPRESENTATIONS, MAKE REFERENCE TO THIS BROCHURE AND TO THE DOCUMENTS REQUIRED BY SECTION 718.503, FLORIDA STATUTES, TO BE FURNISHED BY A DEVELOPER TO A BUYER OR LESSEE. Stated dimensions are measured to the exterior boundaries of the exterior walls and the centerline of interior demising walls and in fact vary from the dimensions that would be determined by using the description and definition of the "Unit" set forth in the Declaration (which generally only includes the interior airspace between the perimeter walls and excludes interior structural components). For your reference, the area of the Unit, determined in accordance with those defined unit boundaries, is described on Exhibit 3 to the Declaration. Note that measurements of rooms set forth on this floor plan are generally taken at the greatest points of each given room (as if the room were a perfect rectangle), without regard for any cutouts. Accordingly, the area of the actual room will typically be smaller than the product obtained by multiplying the stated length times width. All dimensions are approximate and may vary with actual construction, and all floor plans and development plans are subject to change. The name 'Bentley' is a registered trademark. © 2022 Bentley Residences.



Sales Gallery: 18325 Collins Avenue, Sunny Isles Beach, FL 33160
Tel 305 BENTLEY (305 236 8539) bentleyresidencesmiami.com

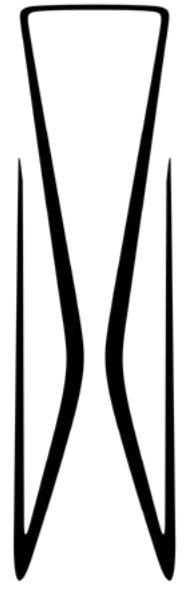

B
BENTLEY
RESIDENCES

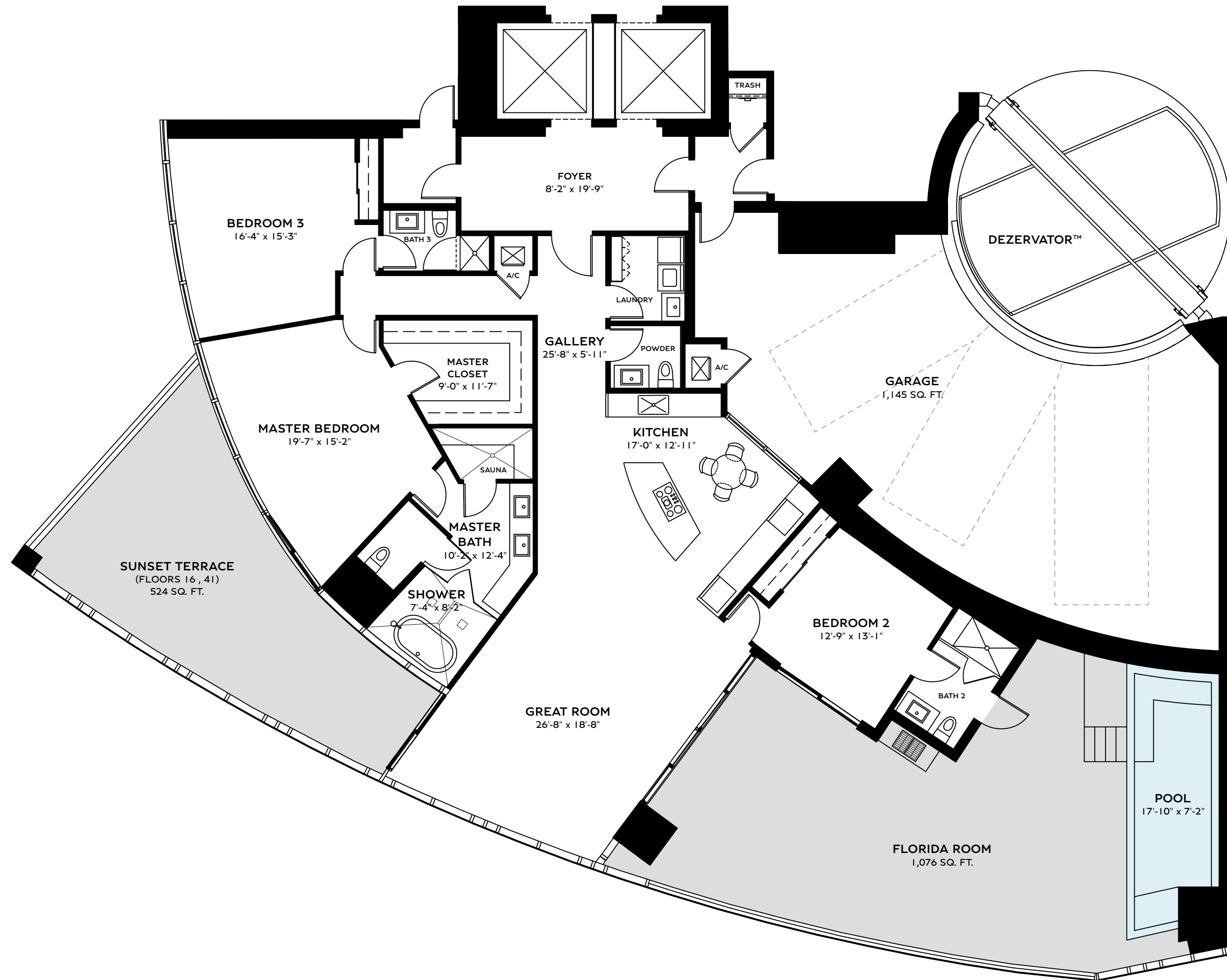

RESIDENCE BENTAYGA
3 BEDS | 3.5 BATHS

FLOORS 16, 41

INTERIOR	2,839 SQ. FT.	263.75 SQ. M.
BALCONY	1,600 SQ. FT.	148.64 SQ. M.
GARAGE	1,145 SQ. FT.	106.37 SQ. M.
TOTAL	5,584 SQ. FT.	518.76 SQ. M.

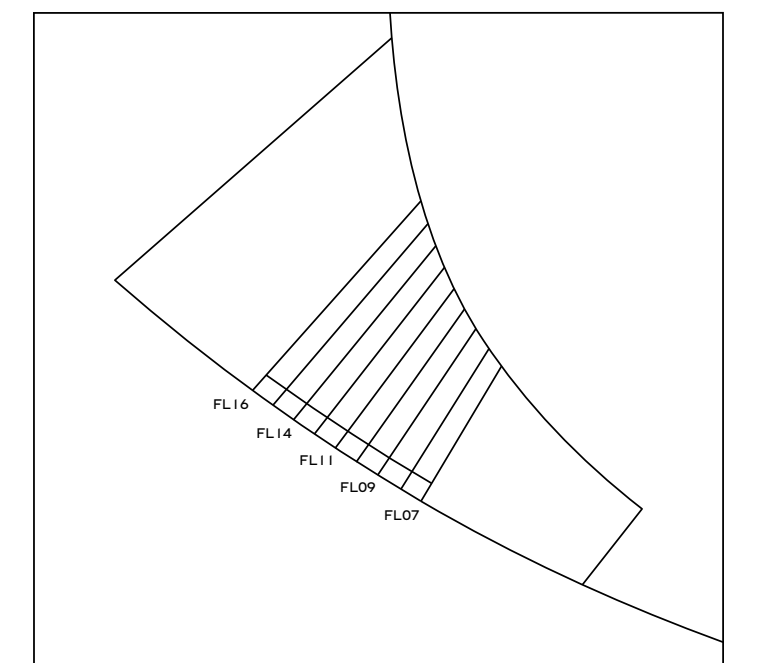
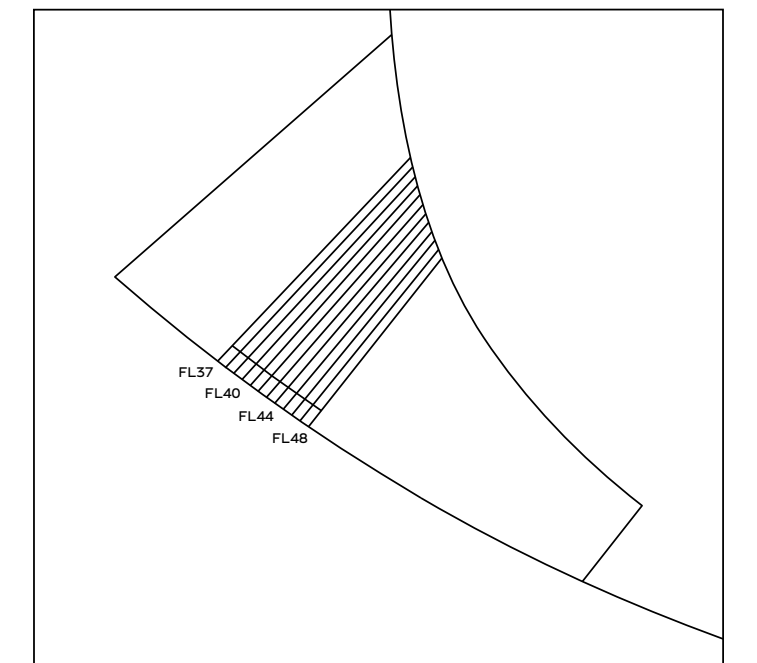

TERRACE AREA VARIES BY FLOOR

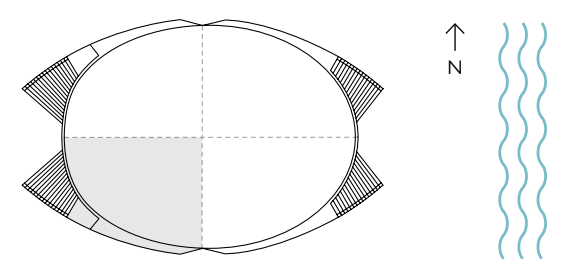

ORAL REPRESENTATIONS CANNOT BE RELIED UPON AS CORRECTLY STATING THE REPRESENTATIONS OF THE DEVELOPER. FOR CORRECT REPRESENTATIONS, MAKE REFERENCE TO THIS BROCHURE AND TO THE DOCUMENTS REQUIRED BY SECTION 718.503, FLORIDA STATUTES, TO BE FURNISHED BY A DEVELOPER TO A BUYER OR LESSEE. Stated dimensions are measured to the exterior boundaries of the exterior walls and the centerline of interior demising walls and in fact vary from the dimensions that would be determined by using the description and definition of the "Unit" set forth in the Declaration (which generally only includes the interior airspace between the perimeter walls and excludes interior structural components). For your reference, the area of the Unit, determined in accordance with those defined unit boundaries, is described on Exhibit 3 to the Declaration. Note that measurements of rooms set forth on this floor plan are generally taken at the greatest points of each given room (as if the room were a perfect rectangle), without regard for any cutouts. Accordingly, the area of the actual room will typically be smaller than the product obtained by multiplying the stated length times width. All dimensions are approximate and may vary with actual construction, and all floor plans and development plans are subject to change. The name 'Bentley' is a registered trademark. © 2022 Bentley Residences.



Sales Gallery: 18325 Collins Avenue, Sunny Isles Beach, FL 33160
Tel 305 BENTLEY (305 236 8539) bentleyresidencesmiami.com

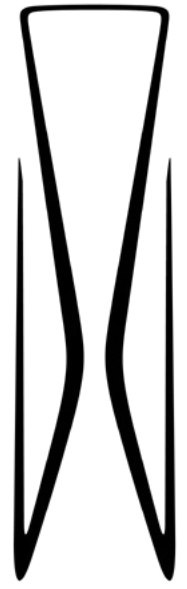

BENTLEY
RESIDENCES

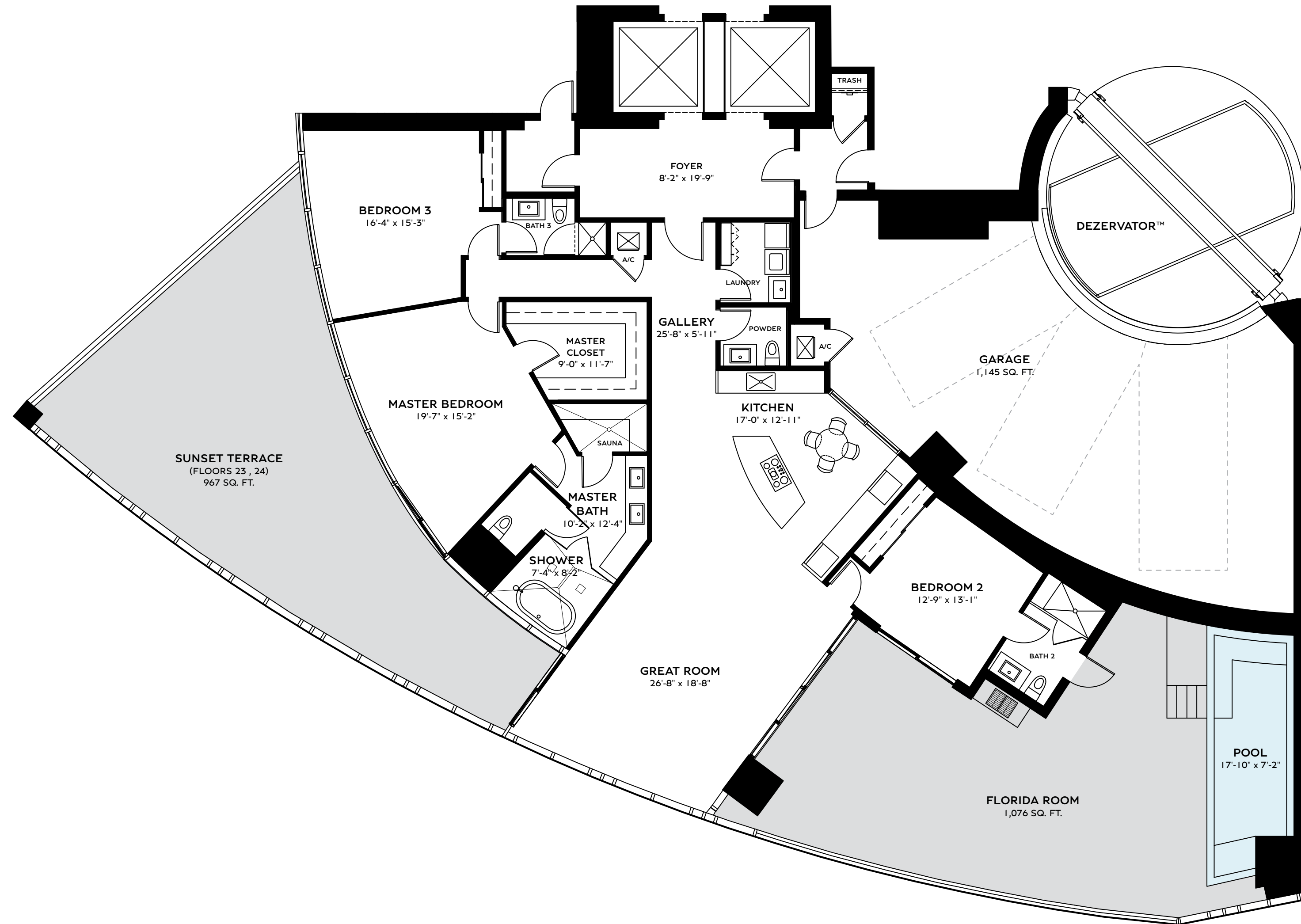

RESIDENCE BENTAYGA
3 BEDS | 3.5 BATHS
FLOORS 23 , 24

INTERIOR	2,839 SQ. FT.	263.75 SQ. M.
BALCONY	2,043 SQ. FT.	189.80 SQ. M.
GARAGE	1,145 SQ. FT.	106.37 SQ. M.
TOTAL	6,027 SQ. FT.	559.92 SQ. M.

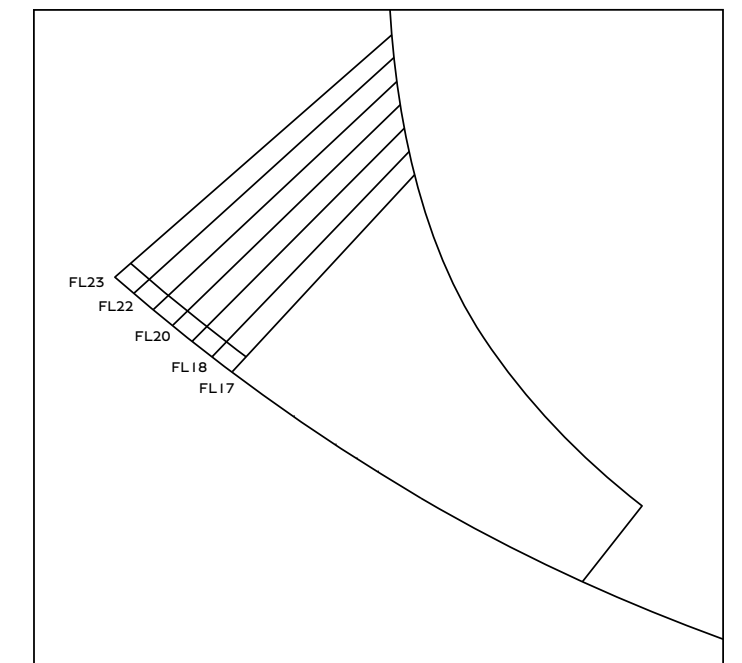
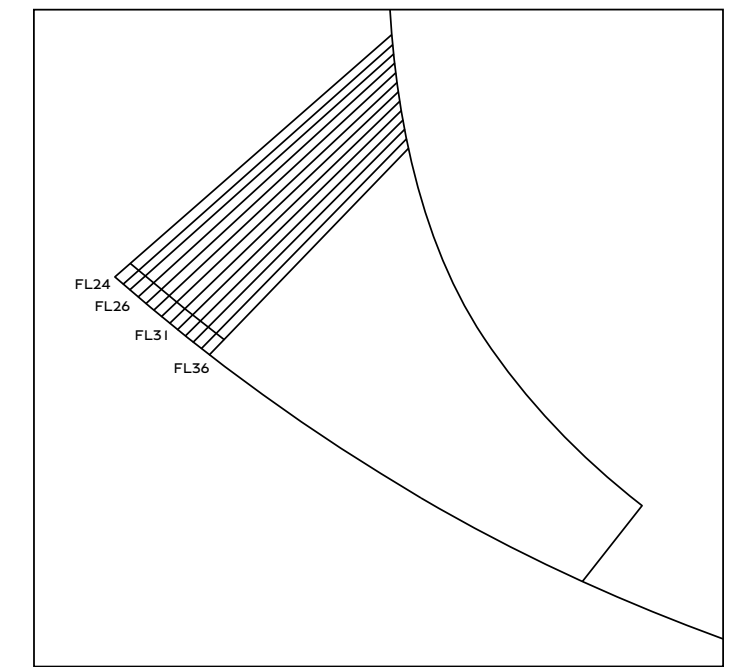

TERRACE AREA VARIES BY FLOOR

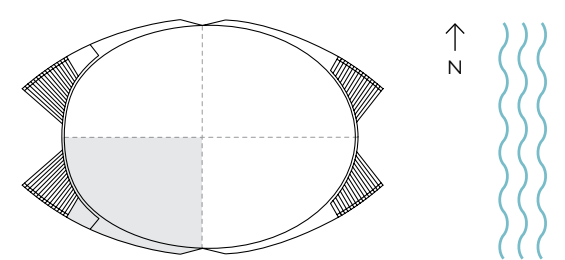

ORAL REPRESENTATIONS CANNOT BE RELIED UPON AS CORRECTLY STATING THE REPRESENTATIONS OF THE DEVELOPER. FOR CORRECT REPRESENTATIONS, MAKE REFERENCE TO THIS BROCHURE AND TO THE DOCUMENTS REQUIRED BY SECTION 718.503, FLORIDA STATUTES, TO BE FURNISHED BY A DEVELOPER TO A BUYER OR LESSEE. Stated dimensions are measured to the exterior boundaries of the exterior walls and the centerline of interior demising walls and in fact vary from the dimensions that would be determined by using the description and definition of the "Unit" set forth in the Declaration (which generally only includes the interior airspace between the perimeter walls and excludes interior structural components). For your reference, the area of the Unit, determined in accordance with those defined unit boundaries, is described on Exhibit 3 to the Declaration. Note that measurements of rooms set forth on this floor plan are generally taken at the greatest points of each given room (as if the room were a perfect rectangle), without regard for any cutouts. Accordingly, the area of the actual room will typically be smaller than the product obtained by multiplying the stated length times width. All dimensions are approximate and may vary with actual construction, and all floor plans and development plans are subject to change. The name 'Bentley' is a registered trademark. © 2022 Bentley Residences.



Sales Gallery: 18325 Collins Avenue, Sunny Isles Beach, FL 33160
Tel 305 BENTLEY (305 236 8539) bentleyresidencesmiami.com